



VOLVO



240 (P242, P244, P245)								08.1974 - 12.1993		
OEM	Info	F / R	Type			Type	F / R	Info	OEM	
1 205 658	Length: 74 mm Cone Size: 14 mm with right-hand thread Inner Thread: M14x2,0mm Outer Thread: M12x1,75mm for steering gear ID: ZF/CAM/TRW			3486	3486			Length: 74 mm Cone Size: 14 mm with right-hand thread Inner Thread: M14x2,0mm Outer Thread: M12x1,75mm for steering gear ID: ZF/CAM/TRW	1 205 658	



3486



3486

260 (P262, P264, P265)								08.1974 - 07.1982		
OEM	Info	F / R	Type			Type	F / R	Info	OEM	
1 205 658	Length: 74 mm Cone Size: 14 mm with right-hand thread Inner Thread: M14x2,0mm Outer Thread: M12x1,75 mm for steering gear ID: ZF/CAM/TRW			3486	3486			Length: 74 mm Cone Size: 14 mm with right-hand thread Inner Thread: M14x2,0mm Outer Thread: M12x1,75 mm for steering gear ID: ZF/CAM/TRW	1 205 658	



3486



3486

440 / 460 / 480						08.1988 - 12.1996				
OEM	Info	F / R	Type			Type	F / R	Info	OEM	
3 410 369	Length: 286 mm Thread Size: M14x1,5 with right-hand thread			6292	6292			Length: 286 mm Thread Size: M14x1,5 with right-hand thread	3 410 369	
3 416 129	Suspension Rod Inner Length: 160 mm Thread Size: M10x1,5			5444	5445			Suspension Rod Inner Length: 160 mm Thread Size: M10x1,5	3 416 130	
3 410 364	Length: 74 mm Inner Thread: M12x1,25 mm with right-hand thread Thread Size: M12x1,25 Cone Size: 14 mm			3487	3487			Length: 74 mm Inner Thread: M12x1,25 mm with right-hand thread Thread Size: M12x1,25 Cone Size: 14 mm	3 410 364	
3 410 519	Thickness/Strength: 16 mm with fastening material			4218	4218			Thickness/Strength: 16 mm with fastening material	3 410 519	



740 / 760 / 780						04.1983 - 08.1992				
OEM	Info	F / R	Type			Type	F / R	Info	OEM	
1 387 463	Axle Vers.: CAM Thread Measurement 1: M14x1,5 Length: 268 mm Thread Size 2: M14x2,0 with right-hand thread			6293	6293			Axle Vers.: CAM Thread Measurement 1: M14x1,5 Length: 268 mm Thread Size 2: M14x2,0 with right-hand thread	1 387 463	
1 387 356	Axle Vers.: ZF Length: 336 mm Pipe Ø: 12 mm Cone Size: 14 mm with right-hand thread			11221	11221			Axle Vers.: ZF Length: 336 mm Pipe Ø: 12 mm Cone Size: 14 mm with right-hand thread	1 387 356	
1 229 297	for control arm			2366	2366			for control arm	1 229 297	
6 819 057	Pressure Rod			2369	2369			Pressure Rod	6 819 057	
1 272 306				2367	2367				1 272 306	
1 329 655				2368	2368				1 329 655	



VOLVO



2369



2369



2367



2367



2368



2368

850					06.1991 - 10.1997				
OEM	Info	F / R	Type		Type	F / R	Info	OEM	
3 546 266	Axle Vers.: TRW Thread Size: M14x2 with right-hand thread			6294	6294		Axle Vers.: TRW Thread Size: M14x2 with right-hand thread	3 546 266	
1 387 860	Suspension Rod			5446	5446		Suspension Rod	1 387 860	
271 598	with accessories			3488	3489		with accessories	271 599	
271 591	with accessories Diameter [mm]: 19			4219	4219		with accessories Diameter [mm]: 19	271 591	
272 273	Control Arm with rubber mounting Steel			1517	1516		Control Arm with rubber mounting Steel	272 337	
271 901	Control Arm with rubber mounting Steel			1519	1518		Control Arm with rubber mounting Steel	271 902	



6294



6294



5446



5446



3488



3489



4219



4219



1517



1516



1519



1518

940 / 960				08.1990 - 12.1994					
OEM	Info	F / R	Type			Type	F / R	Info	OEM
1 387 463	Axle Vers.: CAM Thread Measurement 1: M14x1,5 Length: 268 mm Thread Size 2: M14x2,0 with right-hand thread			6293	6293			Axle Vers.: CAM Thread Measurement 1: M14x1,5 Length: 268 mm Thread Size 2: M14x2,0 with right-hand thread	1 387 463
9 140 788	Thread Measurement 1: M14x1,5 Thread Size 2: M14x2,0 Length: 207 mm			6295	6295			Thread Measurement 1: M14x1,5 Thread Size 2: M14x2,0 Length: 207 mm	9 140 788
1 387 356	Axle Vers.: ZF Length: 336 mm Pipe Ø: 12 mm Cone Size: 14 mm with right-hand thread			11221	11221			Axle Vers.: ZF Length: 336 mm Pipe Ø: 12 mm Cone Size: 14 mm with right-hand thread	1 387 356
272 991	Suspension Rod			5447	5447			Suspension Rod	272 991
1 205 658	Length: 74 mm Cone Size: 14 mm with right-hand thread Inner Thread: M14x2,0mm Outer Thread: M12x1,75 mm for steering gear ID: ZF/CAM/TRW			3486	3486			Length: 74 mm Cone Size: 14 mm with right-hand thread Inner Thread: M14x2,0mm Outer Thread: M12x1,75 mm for steering gear ID: ZF/CAM/TRW	1 205 658
1 229 297	for control arm			2366	2366			for control arm	1 229 297
6 819 057	Pressure Rod			2369	2369			Pressure Rod	6 819 057
6 819 537				2370	2370				6 819 537
1 272 306				2367	2367				1 272 306
1 329 655				2368	2368				1 329 655



VOLVO

940 / 960

08.1990 - 12.1994

2369



2369



2370



2370



2367



2367



2368



2368



C30						-6,2015			
OEM	Info	F / R	Type			Type	F / R	Info	OEM
274 502	Thread Measurement 1:M14x1,5 Thread Size 2:M16x1,5 Length: 275 mm			6085	6085			Thread Measurement 1:M14x1,5 Thread Size 2:M16x1,5 Length: 275 mm	274 502
8 623 576	Suspension Rod Inner Length: 298,1mm			5141	5141			Suspension Rod Inner Length: 298,1mm	8 623 576
274 500	Thread Size: M10x1,5 Thread Size 2: M16x1,5 for vehicles with power steering Hydraulic			3146	3519			Thread Size: M10x1,5 Thread Size 2: M16x1,5 for vehicles with power steering Hydraulic	274 501
31 277 464	Cone Size: 18 mm Thread Size: M14x1,5			4073	4073			Cone Size: 18 mm Thread Size: M14x1,5	31 277 464
31 201 180				4068	4068				31 201 180
30 714 422	Cone Size: 18 mm Control Arm			1294	1295			Cone Size: 18 mm Control Arm	30 714 423
30 666 331	Trailing Arm			2151	2151			Trailing Arm	30 666 331
30 714 466				5142	5142				30 714 466
30 683 067				1278	1278				30 683 067
30 683 067				2152	2152				30 683 067

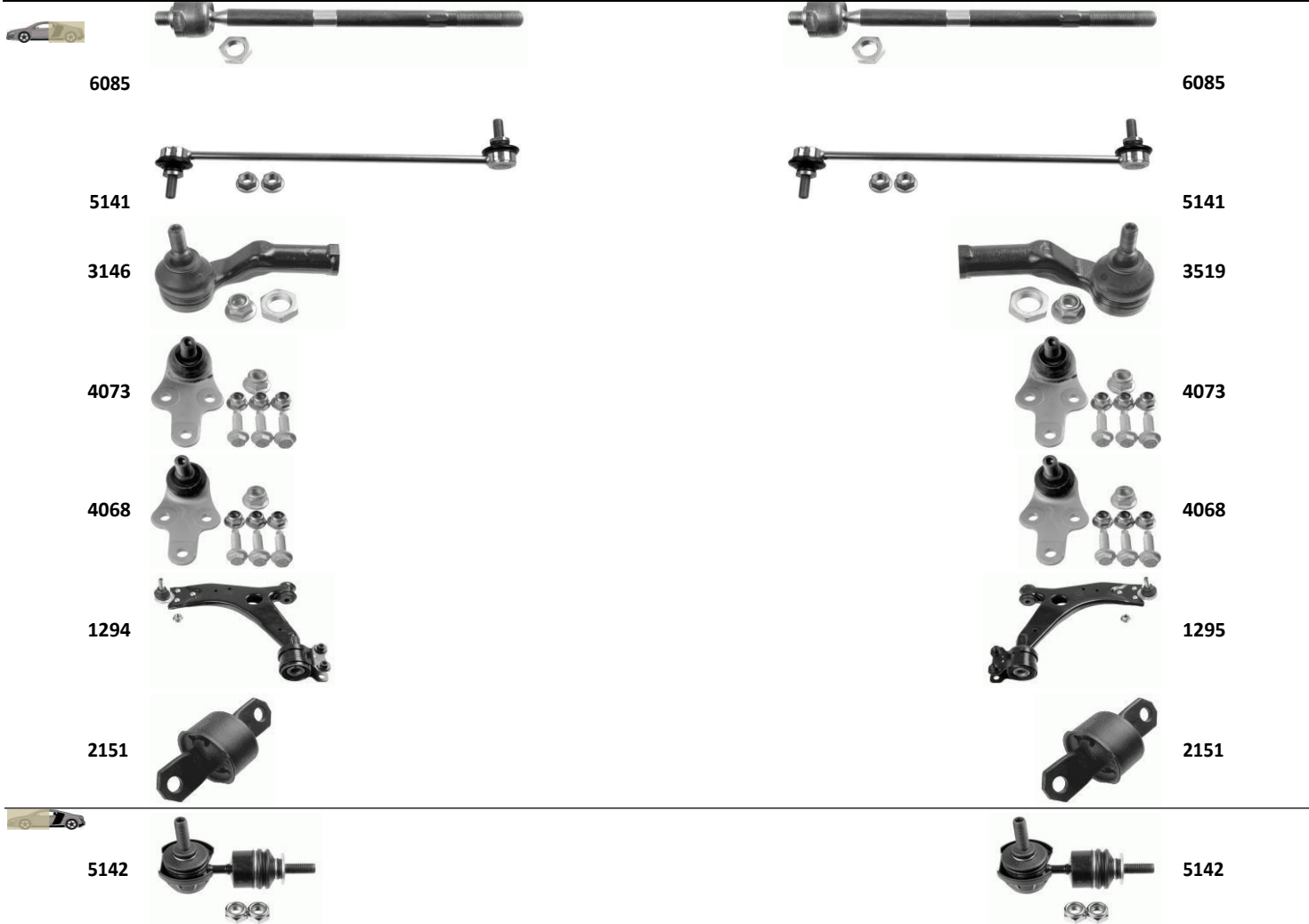

VOLVO

C30

-6,2015



1278



1278



2152



2152

C70 / S70 / V70				03.1998 - 05.2015					
OEM	Info	F / R	Type			Type	F / R	Info	OEM
3 546 266	Axle Vers.: TRW Thread Size: M14x2 with right-hand thread			6294	6294			Axle Vers.: TRW Thread Size: M14x2 with right-hand thread	3 546 266
9 191 410	Length: 162 mm Thread Measurement 1: M16x1,5 Thread Size 2: M14x2,0			6296	6296			Length: 162 mm Thread Measurement 1: M16x1,5 Thread Size 2: M14x2,0	9 191 410
1 387 860	Suspension Rod			5446	5446			Suspension Rod	1 387 860
271 598	with accessories			3488	3489			with accessories	271 599
272 338	Control Arm with rubber mounting Steel			1521	1520			Control Arm with rubber mounting Steel	272 339
272 273	Control Arm with rubber mounting Steel			1517	1516			Control Arm with rubber mounting Steel	272 337
271 901	Control Arm with rubber mounting Steel			1519	1518			Control Arm with rubber mounting Steel	271 902
8 630 604				2383	2383				8 630 604
30 647 920	Suspension Rod Length: 140 mm			5449	5449			Suspension Rod Length: 140 mm	30 647 920



6294



6294

6296



6296

5446



5446

3488



3489

1521



1520

1517



1516

VOLVO



1519



1518



2383



2383



5449



5449

C70 II								-6,2015	
OEM	Info	F / R	Type			Type	F / R	Info	OEM
274 502	Thread Measurement 1:M14x1,5 Thread Size 2: M16x1,5 Length: 275 mm			6085	6085			Thread Measurement 1:M14x1,5 Thread Size 2: M16x1,5 Length: 275 mm	274 502
8 623 576	Suspension Rod Inner Length: 298,1mm			5141	5141			Suspension Rod Inner Length: 298,1mm	8 623 576
274 500	Thread Size: M10x1,5 Thread Size 2: M 16x1,5 for vehicles with power steering Hydraulic			3146	3519			Thread Size: M10x1,5 Thread Size 2: M 16x1,5 for vehicles with power steering Hydraulic	274 501
31 277 464	Cone Size: 18 mm Thread Size: M14x1,5			4073	4073			Cone Size: 18 mm Thread Size: M14x1,5	31 277 464
31 201 180				4068	4068				31 201 180
30 714 422	Cone Size: 18 mm Control Arm			1294	1295			Cone Size: 18 mm Control Arm	30 714 423
30 666 331	Trailing Arm			2151	2151			Trailing Arm	30 666 331
30 714 466				5142	5142				30 714 466
30 683 067				1278	1278				30 683 067
30 683 067				2152	2152				30 683 067



6085



6085



5141



5141



3146



3519



4073



4073



4068



4068



1294



1295



2151



2151

VOLVO

C70 II

-6,2015



5142



5142



1278



1278



2152



2152



S40 / V40				07.1995 - 03.2015					
OEM	Info	F / R	Type	6174	6174	Type	F / R	Info	OEM
3 345 797				6174	6174				3 345 797
274 224	Thread Measurement 1:M16x1,5 Thread Size 2: M14x1,5 Length: 300 mm			6297	6297			Thread Measurement 1:M16x1,5 Thread Size 2: M14x1,5 Length: 300 mm	274 224
30 873 100	Suspension Rod Length: 200 mm Thread Size: M10x1,25			5336	5336			Suspension Rod Length: 200 mm Thread Size: M10x1,25	30 873 100
274 225	Cone Size: 15,3 mm Thread Size 2: M10x1,25 Thread Measurement 1: M14x1,5 with accessories			3490	3491			Cone Size: 15,3 mm Thread Measurement 1: M10x1,25 Thread Size 2: M14x1,5 with accessories	274 226
30 870 695	with right-hand thread Inner Thread: M12x1,25mm			3202	3202			with right-hand thread Inner Thread: M12x1,25mm	30 870 695
30 863 988				4220	4220				30 863 988
30 818 467				2371	2371				30 818 467
30 887 024				2372	2372				30 887 024
30 851 257	for drag link Mounting Type: Rubber-metal Bearing			2373	2373			for drag link Mounting Type: Rubber-metal Bearing	30 851 257
30 852 103	Suspension Rod			5337	5337			Suspension Rod	30 852 103
30 620 785	Length: 143 mm Control Arm			1522	1522			Length: 143 mm Control Arm	30 620 785
30 620 786	Length: 259 mm Control Arm			1523	1523			Length: 259 mm Control Arm	30 620 786

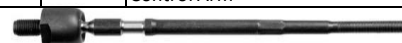

6174

6174

S40 / V40				07.1995 - 03.2015					
-----------	--	--	--	-------------------	--	--	--	--	--

6297



6297



5336



5336



3490



3491



3202



3202



4220



4220



2371



2371



VOLVO

S40 / V40

07.1995 - 03.2015



2372



2372



2373



2373



5337



5337



1522



1522



1523



1523

S40 II									-4,2015
OEM	Info	F / R	Type			Type	F / R	Info	OEM
274 502	Thread Measurement 1:M14x1,5 Thread Size 2: M16x1,5 Length: 275 mm			6085	6085			Thread Measurement 1:M14x1,5 Thread Size 2: M16x1,5 Length: 275 mm	274 502
8 623 576	Suspension Rod Inner Length: 298,1mm			5141	5141			Suspension Rod Inner Length: 298,1 mm	8 623 576
274 500	Thread Size: M10x1,5 Thread Size 2: M 16x1,5 for vehicles with power steering Hydraulic			3146	3519			Thread Size: M10x1,5 Thread Size 2: M 16x1,5 for vehicles with power steering Hydraulic	274 501
31 277 464	Cone Size: 18 mm Thread Size:M14x1,5			4073	4073			Cone Size: 18 mm Thread Size:M14x1,5	31 277 464
31 201 180				4068	4068				31 201 180
30 714 422	Cone Size: 18 mm Control Arm			1294	1295			Cone Size: 18 mm Control Arm	30 714 423
30 666 331	Trailing Arm			2151	2151			Trailing Arm	30 666 331
30 714 128	for control arm Mounting Type:Rubber-metal Bearing			2374	2374			for control arm Mounting Type:Rubber-metal Bearing	30 714 128
3M51 3A262 EJ	for control arm Mounting Type: Hydro Bearing			2375	2375			for control arm Mounting Type: Hydro Bearing	3M51 3A262 EJ
30 714 466				5142	5142				30 714 466
30 683 067				1278	1278				30 683 067
30 683 067				2152	2152				30 683 067
31 201 356				2153	2153				31 201 356



6085



6085



5141



3519



4073



4068



1295



2151



2374



2375



5142



1278



2152



2153

VOLVO

S60 I						07.2000 - 10.2015			
OEM	Info	F / R	Type			Type	F / R	Info	OEM
274 353	Length: 110 mm Thread Size 2: M14x1,5 Thread Measurement 1: M16x1,5			6298	6298			Length: 110 mm Thread Size 2: M14x1,5 Thread Measurement 1: M16x1,5	274 353
274 179	Length: 105 mm Thread Measurement 1: M16x1,5 Thread Size 2: M14x1,5			6299	6299			Length: 105 mm Thread Measurement 1: M16x1,5 Thread Size 2: M14x1,5	274 179
274 303	Suspension Rod with accessories with right-hand thread Thread Size: M10, M12 Length: 332 mm			5448	5448			Suspension Rod with accessories with right-hand thread Thread Size: M10, M12 Length: 332 mm	274 303
274 175	Outer Thread: M12x1,75 mm Inner Thread: M14x1,5 mm with accessories			3492	3493			Outer Thread: M12x1,75 mm Inner Thread: M14x1,5 mm with accessories	274 176
274 186	with accessories Thread Size: M12x1,75 Cone Size: 12,5 mm			4221	4221			with accessories Thread Size: M12x1,75 Cone Size: 12,5 mm	274 186
274 377	with accessories			4222	4222			with accessories	274 377
30 635 229	Control Arm Aluminium			1524	1525			Control Arm Aluminium	30 635 230
9 173 618	Mounting Type: Rubber-metal Bearing			2378	2378			Mounting Type: Rubber-metal Bearing	9 173 618
9 169 204				2379	2379				9 169 204
9 157 572	for OE No.: 9 157 572			2380	2380			for OE No.: 9 157 572	9 157 572
8 630 604				2383	2383				8 630 604
30 647 920	Suspension Rod Length: 140 mm			5449	5449			Suspension Rod Length: 140 mm	30 647 920
9 492 181				2376	2376				9 492 181
9 127 363				2377	2377				9 127 363
8 672 220				2381	2381				8 672 220
30 645 401				2382	2382				30 645 401



6298



6298



6299



6299



5448



5448



3492



3493



4221



4221



4222



4222



1524



1525



2378



2378



2379



2379



2380



2380



2383



2383



5449



5449



2376



2376



2377



2377



2381



2381



2382



2382



VOLVO

S60 II / V60								-10,2015	
OEM	Info	F / R	Type			Type	F / R	Info	OEM
30 776 250	Thread Measurement 1:M16x1,5 Thread Size 2:M18x1,5 Length: 297 mm			6094	6094			Thread Measurement 1:M16x1,5 Thread Size 2:M18x1,5 Length: 297 mm	30 776 250
30 776 255	Thread Measurement 1:M16x1,5 Thread Size 2:M18x1,5 Length: 280 mm			6300	6300			Thread Measurement 1:M16x1,5 Thread Size 2:M18x1,5 Length: 280 mm	30 776 255
30 648 461	Length: 299 mm Suspension Rod			5150	5150			Length: 299 mm Suspension Rod	30 648 461
30 776 249	with right-hand thread Inner Thread: M18x1,5 mm Outer Thread: M14x2,0 mm Cone Size: 20 mm Length: 11,5 mm			3160	3161			with right-hand thread Inner Thread: M18x1,5 mm Outer Thread: M14x2,0 mm Cone Size: 20 mm Length: 11,5 mm	30 776 248
31 277 343				1296	1297				31 277 344
				2174	2173				31 277 755
30 736 875	Suspension Rod Thread Size: M8x1,25,M10x1,5 Length: 179 mm Steel			5459	5459			Suspension Rod Thread Size: M8x1,25,M10x1,5 Length: 179 mm Steel	30 736 875

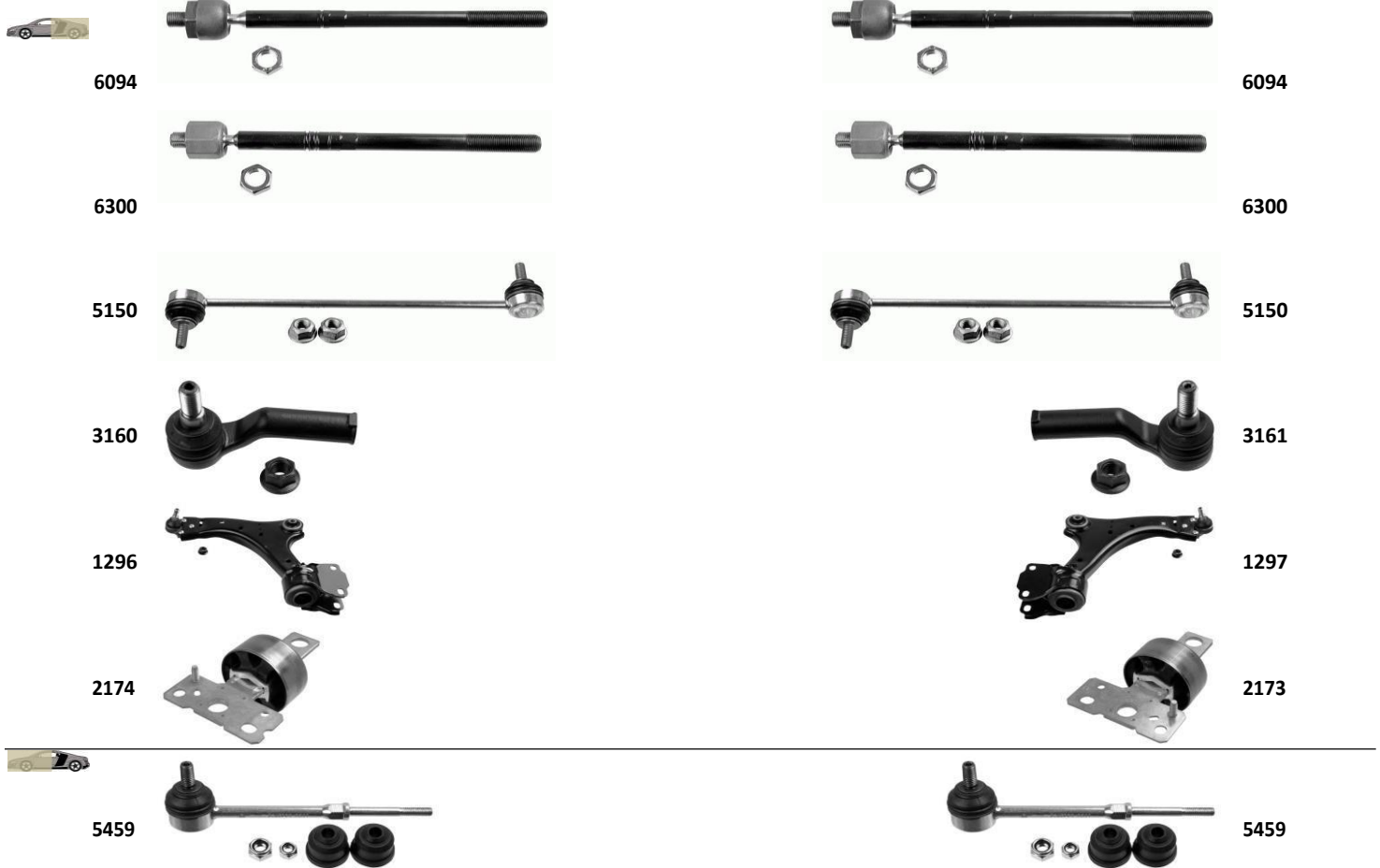

S80 I				05.1998 - 06.2015					
OEM	Info	F / R	Type			Type	F / R	Info	OEM
274 353	Length: 110 mm Thread Size 2: M14x1,5 Thread Measurement 1: M16x1,5			6298	6298			Length: 110 mm Thread Size 2: M14x1,5 Thread Measurement 1: M16x1,5	274 353
272 428	Outer Thread: M14x2 mm, M16x1,5 mm			6301	6301			Outer Thread: M14x2 mm, M16x1,5 mm	272 428
274 179	Length: 105 mm Thread Measurement 1: M16x1,5 Thread Size 2: M14x1,5			6299	6299			Length: 105 mm Thread Measurement 1: M16x1,5 Thread Size 2: M14x1,5	274 179
274 303	Suspension Rod with accessories with right-hand thread Thread Size: M10, M12 Length: 332 mm			5448	5448			Suspension Rod with accessories with right-hand thread Thread Size: M10, M12 Length: 332 mm	274 303
272 416	Length: 249 mm Outer Thread: M12x1,75 mm Cone Size: 15,5 mm Inner Thread: M14x2 mm with accessories			3494	3495			Length: 249 mm Outer Thread: M12x1,75 mm Cone Size: 15,5 mm Inner Thread: M14x2 mm with accessories	272 417
274 175	Outer Thread: M12x1,75 mm Inner Thread: M14x1,5 mm with accessories			3492	3493			Outer Thread: M12x1,75 mm Inner Thread: M14x1,5 mm with accessories	274 176
274 186	with accessories Thread Size: M12x1,75 Cone Size: 12,5 mm			4221	4221			with accessories Thread Size: M12x1,75 Cone Size: 12,5 mm	274 186
30 635 227	Control Arm Aluminium			1526	1602			Control Arm Aluminium	30 635 228
9 173 618	Mounting Type: Rubber-metal Bearing			2378	2378			Mounting Type: Rubber-metal Bearing	9 173 618
9 169 204				2379	2379				9 169 204
8 630 604				2383	2383				8 630 604
30 647 920	Suspension Rod Length: 140 mm			5449	5449			Suspension Rod Length: 140 mm	30 647 920
9 492 181				2376	2376				9 492 181
9 127 363				2377	2377				9 127 363
8 672 220				2381	2381				8 672 220
30 645 401				2382	2382				30 645 401



6298



6298

6301



6301

6299



6299

5448



5448

3494



3495

3492



3493





4221



4221



1526



1602



2378



2378



2379



2379

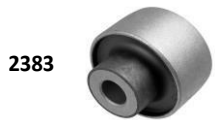

2383



2383



5449



5449



2376



2376



2377

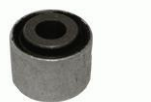

2377



2381



2381



2382



2382

VOLVO

S80 II								-6,2015	
OEM	Info	F / R	Type			Type	F / R	Info	OEM
30 776 250	Thread Measurement 1:M16x1,5 Thread Size 2:M18x1,5 Length: 297 mm			6094	6094			Thread Measurement 1:M16x1,5 Thread Size 2:M18x1,5 Length: 297 mm	30 776 250
30 776 255	Thread Measurement 1:M16x1,5 Thread Size 2:M18x1,5 Length: 280 mm			6300	6300			Thread Measurement 1:M16x1,5 Thread Size 2:M18x1,5 Length: 280 mm	30 776 255
30 648 461	Length: 299 mm Suspension Rod			5150	5150			Length: 299 mm Suspension Rod	30 648 461
30 776 249	with right-hand thread Inner Thread: M18x1,5 mm Outer Thread: M14x2,0 mm Cone Size: 20 mm Length: 11,5 mm			3160	3161			with right-hand thread Inner Thread: M18x1,5 mm Outer Thread: M14x2,0 mm Cone Size: 20 mm Length: 11,5 mm	30 776 248
30 671 636	Cone Size: 22 mm for control arm Outer Thread 1: M14x1,5 mm with accessories			4074	4074			Cone Size: 22 mm for control arm Outer Thread 1: M14x1,5 mm with accessories	30 671 636
31 277 343				1296	1297				31 277 344
				2174	2173				31 277 755
30 736 875	Suspension Rod Thread Size: M8x1,25,M10x1,5 Length: 179 mm Steel			5459	5459			Suspension Rod Thread Size: M8x1,25,M10x1,5 Length: 179 mm Steel	30 736 875



S90 / V90

11.1996 - 12.1998

5459



5459



S90 / V90

11.1996 - 12.1998

OEM	Info	F / R	Type			Type	F / R	Info	OEM
1 387 463	Axle Vers.: CAM Thread Measurement 1: M14x1,5 Length: 268 mm Thread Size 2: M14x2,0 with right-hand thread			6293	6293			Axle Vers.: CAM Thread Measurement 1: M14x1,5 Length: 268 mm Thread Size 2: M14x2,0 with right-hand thread	1 387 463
272 991	Suspension Rod			5447	5447			Suspension Rod	272 991
271 598	with accessories			3488	3489			with accessories	271 599
6 819 537				2370	2370				6 819 537

6293



6293



5447



5447



3488



3489



V50 (MW)

-4,2015

2370



2370



V50 (MW)

-4,2015

OEM	Info	F / R	Type			Type	F / R	Info	OEM
274 502	Thread Measurement 1: M14x1,5 Thread Size 2: M16x1,5 Length: 275 mm			6085	6085			Thread Measurement 1: M14x1,5 Thread Size 2: M16x1,5 Length: 275 mm	274 502
8 623 576	Suspension Rod Inner Length: 298,1 mm			5141	5141			Suspension Rod Inner Length: 298,1 mm	8 623 576
274 500	Thread Size: M10x1,5 Thread Size 2: M16x1,5 for vehicles with power steering Hydraulic			3146	3519			Thread Size: M10x1,5 Thread Size 2: M16x1,5 for vehicles with power steering Hydraulic	274 501
31 277 464	Cone Size: 18 mm Thread Size: M14x1,5			4073	4073			Cone Size: 18 mm Thread Size: M14x1,5	31 277 464
31 201 180				4068	4068				31 201 180
30 714 422	Cone Size: 18 mm Control Arm			1294	1295			Cone Size: 18 mm Control Arm	30 714 423
30 666 331	Trailing Arm			2151	2151			Trailing Arm	30 666 331
30 714 128	for control arm Mounting Type: Rubber-metal Bearing			2374	2374			for control arm Mounting Type: Rubber-metal Bearing	30 714 128
3M51 3A262 EJ	for control arm Mounting Type: Hydro Bearing			2375	2375			for control arm Mounting Type: Hydro Bearing	3M51 3A262 EJ
30 714 466				5142	5142				30 714 466
30 683 067				1278	1278				30 683 067
30 683 067				2152	2152				30 683 067
31 201 356				2153	2153				31 201 356

VOLVO

V50 (MW)

-4,2015



6085



6085

5141



5141

3146



3519

4073



4073

4068



4068

1294



1295

2151



2151

2374



2374

2375



2375



5142



5142

1278



1278

2152



2152

2153



2153



OEM	Info	F / R	Type			Type	F / R	Info	OEM
274 353	Length: 110 mm Thread Size 2: M14x1,5 Thread Measurement 1: M16x1,5			6298	6298			Length: 110 mm Thread Size 2: M14x1,5 Thread Measurement 1: M16x1,5	274 353
274 179	Length: 105 mm Thread Measurement 1: M16x1,5 Thread Size 2: M14x1,5			6299	6299			Length: 105 mm Thread Measurement 1: M16x1,5 Thread Size 2: M14x1,5	274 179
274 303	Suspension Rod with accessories with right-hand thread Thread Size: M10, M12 Length: 332 mm			5448	5448			Suspension Rod with accessories with right-hand thread Thread Size: M10, M12 Length: 332 mm	274 303
274 175	Outer Thread: M12x1,75 mm Inner Thread: M14x1,5 mm with accessories			3492	3493			Outer Thread: M12x1,75 mm Inner Thread: M14x1,5 mm with accessories	274 176
274 186	with accessories Thread Size: M12x1,75 Cone Size: 12,5 mm			4221	4221			with accessories Thread Size: M12x1,75 Cone Size: 12,5 mm	274 186
274 377	with accessories			4222	4222			with accessories	274 377
30 635 229	Control Arm Aluminium			1524	1525			Control Arm Aluminium	30 635 230
9 173 618	Mounting Type: Rubber-metal Bearing			2378	2378			Mounting Type: Rubber-metal Bearing	9 173 618
9 169 204				2379	2379				9 169 204
8 630 604				2383	2383				8 630 604
30 647 920	Suspension Rod Length: 140 mm			5449	5449			Suspension Rod Length: 140 mm	30 647 920
9 492 181				2376	2376				9 492 181
9 127 363				2377	2377				9 127 363
8 672 220				2381	2381				8 672 220
30 645 401				2382	2382				30 645 401



6298



6298



6299



6299



5448



5448



3492



3493



4221



4221



4222



4222



VOLVO

V70 II (P80_, SW)

03.2000 - 07.2015

1524



1525



2378



2378



2379



2379



2383



2383



5449



5449



2376



2376



2377



2377



2381



2381



2382



2382



V70 III (BW)								-7,2015	
OEM	Info	F / R	Type			Type	F / R	Info	OEM
30 776 250	Thread Measurement 1:M16x1,5 Thread Size 2:M18x1,5 Length: 297 mm			6094	6094			Thread Measurement 1:M16x1,5 Thread Size 2:M18x1,5 Length: 297 mm	30 776 250
30 776 255	Thread Measurement 1:M16x1,5 Thread Size 2:M18x1,5 Length: 280 mm			6300	6300			Thread Measurement 1:M16x1,5 Thread Size 2:M18x1,5 Length: 280 mm	30 776 255
30 648 461	Length: 299 mm Suspension Rod			5150	5150			Length: 299 mm Suspension Rod	30 648 461
30 776 249	with right-hand thread Inner Thread: M18x1,5 mm Outer Thread: M14x2,0 mm Cone Size: 20 mm Length: 11,5 mm			3160	3161			with right-hand thread Inner Thread: M18x1,5 mm Outer Thread: M14x2,0 mm Cone Size: 20 mm Length: 11,5 mm	30 776 248
30 671 636	Cone Size: 22 mm for control arm Outer Thread 1: M14x1,5 mm with accessories			4074	4074			Cone Size: 22 mm for control arm Outer Thread 1: M14x1,5 mm with accessories	30 671 636
31 277 343				1296	1297				31 277 344
				2174	2173				31 277 755
30 736 875	Suspension Rod Thread Size: M8x1,25, M10x1,5 Length: 179 mm Steel			5459	5459			Suspension Rod Thread Size: M8x1,25, M10x1,5 Length: 179 mm Steel	30 736 875



VOLVO

XC60

-8,2015

5459



5459



XC60								-8,2015	
OEM	Info	F / R	Type			Type	F / R	Info	OEM
31 280 408	Thread Measurement 1:M16x1,5 Thread Size 2:M18x1,5 Length: 295 mm for vehicles with speed-dependent power steering			6302	6302			Thread Measurement 1:M16x1,5 Thread Size 2:M18x1,5 Length: 295 mm for vehicles with speed-dependent power steering	31 280 408
30 648 461	Length: 299 mm Suspension Rod			5150	5150			Length: 299 mm Suspension Rod	30 648 461
30 776 249	with right-hand thread Inner Thread: M18x1,5 mm Outer Thread: M14x2,0 mm Cone Size: 20 mm Length: 11,5 mm			3160	3161			with right-hand thread Inner Thread: M18x1,5 mm Outer Thread: M14x2,0 mm Cone Size: 20 mm Length: 11,5 mm	30 776 248
				2174	2173				31 277 755
30 736 875	Suspension Rod Thread Size: M8x1,25,M10x1,5 Length: 179 mm Steel			5459	5459			Suspension Rod Thread Size: M8x1,25,M10x1,5 Length: 179 mm Steel	30 736 875

6302



6302



5150



5150



3160



3161



2174



2173





















5459



5459



XC70 I				11.1997 - 07.2015					
OEM	Info	F / R	Type			Type	F / R	Info	OEM
274 353	Length: 110 mm Thread Size 2: M14x1,5 Thread Measurement 1: M16x1,5			6298	6298			Length: 110 mm Thread Size 2: M14x1,5 Thread Measurement 1: M16x1,5	274 353
274 179	Length: 105 mm Thread Measurement 1: M16x1,5 Thread Size 2: M14x1,5			6299	6299			Length: 105 mm Thread Measurement 1: M16x1,5 Thread Size 2: M14x1,5	274 179
274 303	Suspension Rod with accessories with right-hand thread Thread Size: M10, M12 Length: 332 mm			5448	5448			Suspension Rod with accessories with right-hand thread Thread Size: M10, M12 Length: 332 mm	274 303
274 191	Outer Thread: M12x1,75 mm with accessories			3496	3498			Outer Thread: M12x1,75 mm with accessories	274 192
274 186	with accessories Thread Size: M12x1,75 Cone Size: 12,5 mm			4221	4221			with accessories Thread Size: M12x1,75 Cone Size: 12,5 mm	274 186
274 377	with accessories			4222	4222			with accessories	274 377
9 173 618	Mounting Type: Rubber-metal Bearing			2378	2378			Mounting Type: Rubber-metal Bearing	9 173 618
30 647 920	Suspension Rod Length: 140 mm			5449	5449			Suspension Rod Length: 140 mm	30 647 920
9 200 154				2384	2384				9 200 154



6298



6298

XC70 I

11.1997 - 07.2015

6299



6299

5448



5448

3496



3498

4221



4221

4222



4222

2378



2378

VOLVO

XC70 I

11.1997 - 07.2015



XC70 II								-7,2015	
OEM	Info	F / R	Type			Type	F / R	Info	OEM
30 776 250	Thread Measurement 1:M16x1,5 Thread Size 2:M18x1,5 Length: 297 mm			6094	6094			Thread Measurement 1:M16x1,5 Thread Size 2:M18x1,5 Length: 297 mm	30 776 250
30 776 255	Thread Measurement 1:M16x1,5 Thread Size 2:M18x1,5 Length: 280 mm			6300	6300			Thread Measurement 1:M16x1,5 Thread Size 2:M18x1,5 Length: 280 mm	30 776 255
30 648 461	Length: 299 mm Suspension Rod			5150	5150			Length: 299 mm Suspension Rod	30 648 461
30 776 249	with right-hand thread Inner Thread: M18x1,5 mm Outer Thread: M14x2,0 mm Cone Size: 20 mm Length: 11,5 mm			3160	3161			with right-hand thread Inner Thread: M18x1,5 mm Outer Thread: M14x2,0 mm Cone Size: 20 mm Length: 11,5 mm	30 776 248
30 683 248	Cone Size: 19 mm for control arm			4223	4223			Cone Size: 19 mm for control arm	30 683 248
				2174	2173				31 277 755
30 736 875	Suspension Rod Thread Size: M8x1,25, M10x1,5 Length: 179 mm Steel			5459	5459			Suspension Rod Thread Size: M8x1,25, M10x1,5 Length: 179 mm Steel	30 736 875

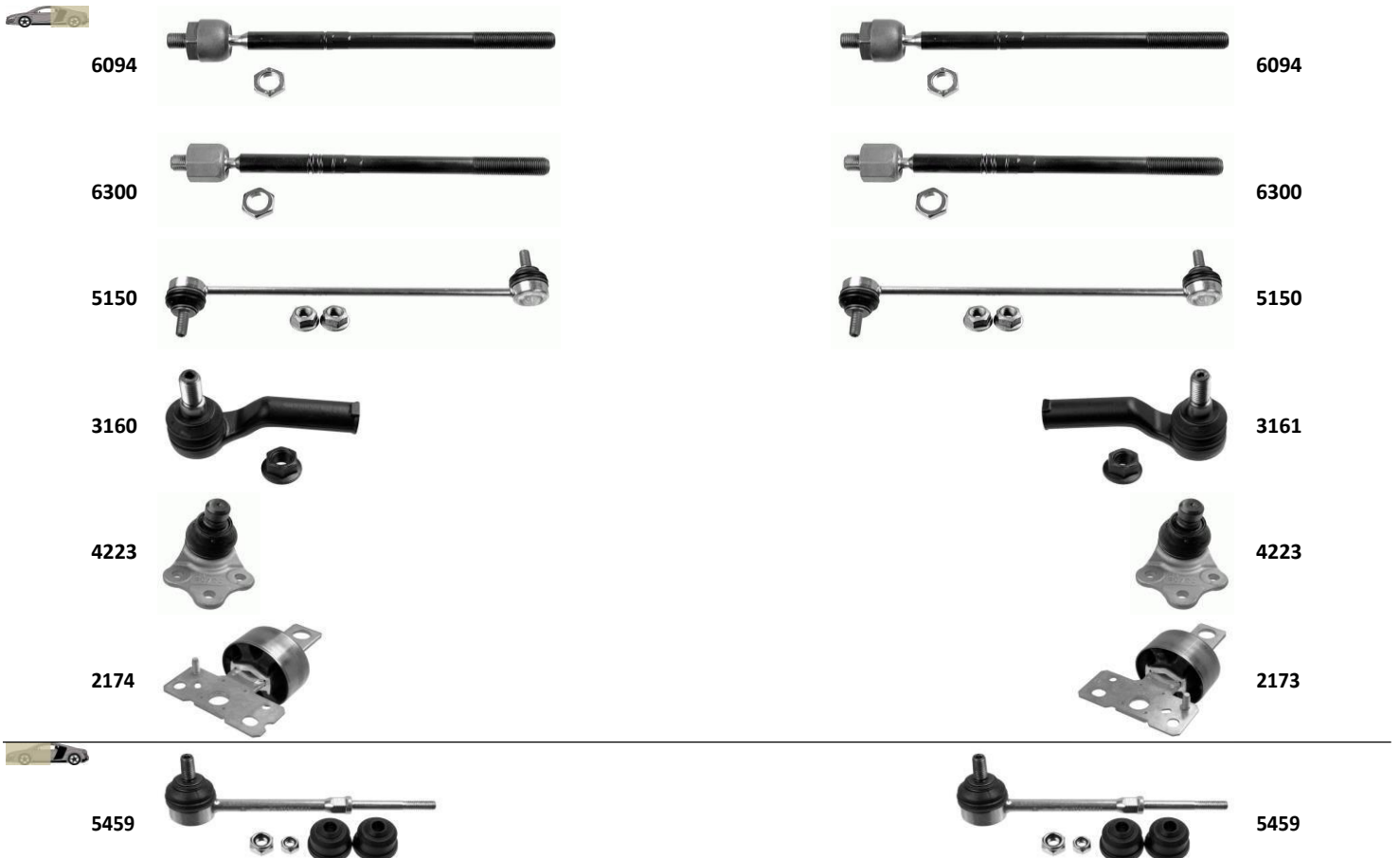

VOLVO

XC90								-2,2015	
OEM	Info	F / R	Type			Type	F / R	Info	OEM
274 353	Length: 110 mm Thread Size 2: M14x1,5 Thread Measurement 1: M16x1,5			6298	6298			Length: 110 mm Thread Size 2: M14x1,5 Thread Measurement 1: M16x1,5	274 353
274 303	Suspension Rod with accessories with right-hand thread Thread Size: M10, M12 Length: 332 mm			5448	5448			Suspension Rod with accessories with right-hand thread Thread Size: M10, M12 Length: 332 mm	274 303
274 377	with accessories			4222	4222			with accessories	274 377
30 645 847	Mounting Type: Rubber-metal Bearing			2385	2385			Mounting Type: Rubber-metal Bearing	30 645 847
30 639 368	Mounting Type: Rubber-metal Bearing			2386	2386			Mounting Type: Rubber-metal Bearing	30 639 368
30 647 920	Suspension Rod Length: 140 mm			5449	5449			Suspension Rod Length: 140 mm	30 647 920
9 200 154				2384	2384				9 200 154

