

# RENAULT

14										05.1976 - 12.1983	
OEM	Info	F / R	Type			Type	F / R	Info	OEM		
77 01 461 141	with accessories with right-hand thread Outer Thread 1: M14x1,5 mm Outer Thread: M10x1,5 mm			3400	3400			with accessories with right-hand thread Outer Thread 1: M14x1,5 mm Outer Thread: M10x1,5 mm	77 01 461 141		



3400



3400

18										04.1978 - 11.1993	
OEM	Info	F / R	Type			Type	F / R	Info	OEM		
77 01 461 141	with accessories with right-hand thread Outer Thread 1: M14x1,5 mm Outer Thread: M10x1,5 mm			3400	3400			with accessories with right-hand thread Outer Thread 1: M14x1,5 mm Outer Thread: M10x1,5 mm	77 01 461 141		



3400



3400

19										01.1988 - 09.1994	
OEM	Info	F / R	Type			Type	F / R	Info	OEM		
77 01 465 915	with accessories for OE No.: 77 01 465 915			6222	6222			with accessories for OE No.: 77 01 465 915	77 01 465 915		
77 01 462 182	for vehicles without ABS Thread Size: M10 with fastening material			4180	4180			for vehicles without ABS Thread Size: M10 with fastening material	77 01 462 182		
77 01 472 038	Total Length: 124 mm Thickness/Strength: 16 mm Thread Size: M10 with fastening material			4181	4181			Total Length: 124 mm Thickness/Strength: 16 mm Thread Size: M10 with fastening material	77 01 472 038		
77 00 436 302	Control Arm Sheet Steel			1468	1469			Control Arm Sheet Steel	77 00 436 303		
77 00 789 478	Mounting Type: Rubber-metal Bearing			2320	2320			Mounting Type: Rubber-metal Bearing	77 00 789 478		
77 00 789 477				2321	2321				77 00 789 477		



6222



6222

4180



4180

4181



4181

# RENAULT

19

01.1988 - 09.1994



1468



1469



2320



2320



2321



2321

## 20 (127\_)

10.1975 - 12.1983

OEM	Info	F / R	Type			Type	F / R	Info	OEM
77 01 461 141	with accessories with right-hand thread Outer Thread 1: M14x1,5 mm Outer Thread: M10x1,5 mm			3400	3400			with accessories with right-hand thread Outer Thread 1: M14x1,5 mm Outer Thread: M10x1,5 mm	77 01 461 141
77 01 461 770	with right-hand thread Outer Thread: M14x1,5 mm			3366	3366			with right-hand thread Outer Thread: M14x1,5 mm	77 01 461 770



3400



3400



3366



3366

## 21 (B48\_ , K48\_ , L48\_ )

09.1989 - 06.1994

OEM	Info	F / R	Type			Type	F / R	Info	OEM
77 01 461 141	with accessories with right-hand thread Outer Thread 1: M14x1,5 mm Outer Thread: M10x1,5 mm			3400	3400			with accessories with right-hand thread Outer Thread 1: M14x1,5 mm Outer Thread: M10x1,5 mm	77 01 461 141
77 01 462 182	for vehicles without ABS Thread Size: M10 with fastening material			4180	4180			for vehicles without ABS Thread Size: M10 with fastening material	77 01 462 182
77 04 000 681	Thickness/Strength: 46,0 mm, 35,0 mm Inner Diameter: 12 mm Outer Diameter: 32 mm			2322	2322			Thickness/Strength: 46,0 mm, 35,0 mm Inner Diameter: 12 mm Outer Diameter: 32 mm	77 04 000 681



3400



3400



4180



4180

# RENAULT

25 (B29\_)

04.1984 - 12.1993

2322



2322



25 (B29_)				04.1984 - 12.1993					
OEM	Info	F / R	Type			Type	F / R	Info	OEM
77 01 464 313	Length: 173,5 mm with accessories			6356	6356			Length: 173,5 mm with accessories	77 01 464 313
77 01 464 313	with accessories			11143	11143			with accessories	77 01 464 313
77 01 461 141	with accessories with right-hand thread Outer Thread 1: M14x1,5 mm Outer Thread: M10x1,5 mm			3400	3400			with accessories with right-hand thread Outer Thread 1: M14x1,5 mm Outer Thread: M10x1,5 mm	77 01 461 141
77 00 781 463	Thickness/Strength: 10,0 mm Inner Diameter: 36 mm Thread Size: M10x1,5 for control arm			2323	2323			Thickness/Strength: 10,0 mm Inner Diameter: 36 mm Thread Size: M10x1,5 for control arm	77 00 781 463



6356



6356



11143



11143



3400



3400



2323



2323



30 (127\_)

02.1975 - 03.1986

30 (127_)				02.1975 - 03.1986					
OEM	Info	F / R	Type			Type	F / R	Info	OEM
77 01 461 141	with accessories with right-hand thread Outer Thread 1: M14x1,5 mm Outer Thread: M10x1,5 mm			3400	3400			with accessories with right-hand thread Outer Thread 1: M14x1,5 mm Outer Thread: M10x1,5 mm	77 01 461 141
77 01 461 770	with right-hand thread Outer Thread: M14x1,5 mm			3366	3366			with right-hand thread Outer Thread: M14x1,5 mm	77 01 461 770



3400



3400



3366



3366



# RENAULT

9 (L42_) / 11 (B/C37_)								03.1983 - 07.1989	
OEM	Info	F / R	Type			Type	F / R	Info	OEM
77 01 462 182	for vehicles without ABS Thread Size: M10 with fastening material			4180	4180			for vehicles without ABS Thread Size: M10 with fastening material	77 01 462 182
77 01 472 038	Total Length: 124 mm Thickness/Strength: 16 mm Thread Size: M10 with fastening material			4181	4181			Total Length: 124 mm Thickness/Strength: 16 mm Thread Size: M10 with fastening material	77 01 472 038



AVANTIME (DE0_)								09.2001 - 03.2015	
OEM	Info	F / R	Type			Type	F / R	Info	OEM
60 25 370 493	Length: 234 mm Thread Size: M12x1,0 Outer Thread: M14x1,5 mm with accessories			6357	6357			Length: 234 mm Thread Size: M12x1,0 Outer Thread: M14x1,5 mm with accessories	60 25 370 493
60 25 370 493	with accessories			11144	11145			with accessories	60 25 370 494
77 00 805 494	Suspension Rod			5402	5402			Suspension Rod	77 00 805 494
60 00 022 762	Cone Size: 14,6 mm Length: 202 mm Inner Thread: M14x1,5 mm with right-hand thread			3402	3401			Cone Size: 14,6 mm Length: 202 mm Inner Thread: M14x1,5 mm with right-hand thread	60 00 022 761
60 25 308 155				4182	4182				60 25 308 155
60 25 305 572	Control Arm with ball joint, with rubber mounting			1470	1471			Control Arm with ball joint, with rubber mounting	60 25 305 573
77 00 822 503	Mounting Type: Rubber-metal Bearing			2324	2324			Mounting Type: Rubber-metal Bearing	77 00 822 503
60 25 311 529	Mounting Type: Rubber-metal Bearing for control arm			2325	2325			Mounting Type: Rubber-metal Bearing for control arm	60 25 311 529



# RENAULT



CLIO I				05.1990 - 09.1998					
OEM	Info	F / R	Type			Type	F / R	Info	OEM
60 00 022 807	Thread Measurement 1: M12x1,0 Thread Size 2: M14x1,5 with internal thread Length: 226 mm with accessories			6358	6358			Thread Measurement 1: M12x1,0 Thread Size 2: M14x1,5 with internal thread Length: 226 mm with accessories	60 00 022 807
77 01 469 777	Thread Measurement 1: M12x1,0 Thread Size 2: M14x1,5 Length: 230 mm with accessories Outer Thread			6226	6226			Thread Measurement 1: M12x1,0 Thread Size 2: M14x1,5 Length: 230 mm with accessories Outer Thread	77 01 469 777
77 00 799 404	Coupling Rod			5352	5352			Coupling Rod	77 00 799 404
60 00 022 720	with right-hand thread Thread Size: M14x1,5 Inner Thread: M14x1,5 mm			3403	3404			with right-hand thread Thread Size: 14x1,5 Inner Thread: M14x1,5 mm	60 00 022 721
77 01 462 182	for vehicles without ABS Thread Size: M10 with fastening material			4180	4180			for vehicles without ABS Thread Size: M10 with fastening material	77 01 462 182
77 00 828 843	Thickness/Strength: 16 mm Flange Hole Diameter: 10,05 mm with fastening material Thread Size: M10			4183	4183			Thickness/Strength: 16 mm Flange Hole Diameter: 10,05 mm with fastening material Thread Size: M10	77 00 828 843
77 00 794 386	Control Arm with rubber mounting, with ball joint Sheet Steel			1474	1475			Control Arm with rubber mounting, with ball joint Sheet Steel	77 00 794 387
77 00 789 477				2321	2321				77 00 789 477
7700799064				2326	2326				7700799064
7700799065				2327	2327				7700799065

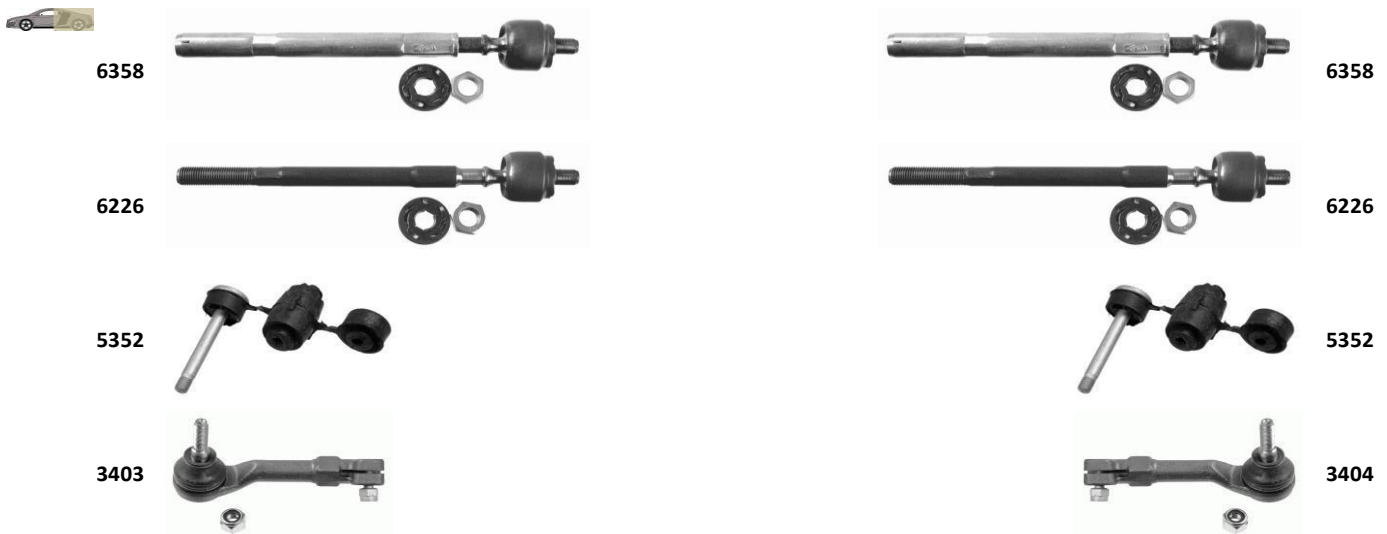

# RENAULT

4180



4180



4183



4183



1474



1475



2321



2321



2326



2326



























































2327



2327



# RENAULT

CLIO II				12.1899 - 09.1998					
OEM	Info	F / R	Type			Type	F / R	Info	OEM
77 01 471 124	with accessories			6227	6227			with accessories	77 01 471 124
77 01 472 734	Length: 282 mm Thread Measurement 1: M14x1,5 Thread Size 2: M14x1,5 with accessories			6228	6228			Length: 282 mm Thread Measurement 1: M14x1,5 Thread Size 2: M14x1,5 with accessories	77 01 472 734
77 01 472 120	Length: 282 mm Thread Measurement 1: M12x1,0 Thread Size 2: M14x1,5 with accessories for vehicles with power steering			6340	6340			Length: 282 mm Thread Measurement 1: M12x1,0 Thread Size 2: M14x1,5 with accessories for vehicles with power steering	77 01 472 120
77 01 471 143	for steering manufacturer: TRW with accessories Thread Size: M14x1,5			6229	6229			for steering manufacturer: TRW with accessories Thread Size: M14x1,5	77 01 471 143
77 01 472 113	Length: 302 mm Outer Thread: M12x1,0 mm, M14x1,5 mm with accessories			6341	6341			Length: 302 mm Outer Thread: M12x1,0 mm, M14x1,5 mm with accessories	77 01 472 113
77 01 471 125	Length: 218 mm Thread Measurement 1: M12x1,0 Thread Size 2: M14x1,5 for steering manufacturer: SMI with accessories			6230	6230			Length: 218 mm Thread Measurement 1: M12x1,0 Thread Size 2: M14x1,5 for steering manufacturer: SMI with accessories	77 01 471 125
77 00 799 404	Coupling Rod with accessories			5352	5352			Coupling Rod with accessories	77 00 799 404
77 01 047 415	Cone Size: 14,6 mm Thread Size: M10x1,25 Inner Thread: M14x1,5 mm			3346	3347			Cone Size: 14,6 mm Thread Size: M10x1,25 Inner Thread: M14x1,5 mm	77 01 047 416
77 01 471 126	Cone Size: 14,6 mm Inner Thread: M14x1,5 mm Outer Thread: M10x1,25 mm			3405	3406			Cone Size: 14,6 mm Inner Thread: M14x1,5 mm Outer Thread: M10x1,25 mm	77 01 471 127
77 01 472 038	Total Length: 124 mm Thickness/Strength: 16 mm Thread Size: M10 with fastening material			4181	4181			Total Length: 124 mm Thickness/Strength: 16 mm Thread Size: M10 with fastening material	77 01 472 038
82 00 681 176	Thickness/Strength: 18 mm Bore Ø: 12 mm Thread Size: M12 with fastening material			4184	4184			Thickness/Strength: 18 mm Bore Ø: 12 mm Thread Size: M12 with fastening material	82 00 681 176
77 00 425 227	Control Arm with ball joint, with rubber mounting Sheet Steel			1476	1477			Control Arm with ball joint, with rubber mounting Sheet Steel	77 00 425 228
77 00 424 399	Mounting Type: Rubber-metal Bearing for control arm			2328	2328			Mounting Type: Rubber-metal Bearing for control arm	77 00 424 399
77 00 789 477				2321	2321				77 00 789 477



# RENAULT

CLIO II

12.1899 - 09.1998





# RENAULT

CLIO III										12.1899 - 08.2015	
OEM	Info	F / R	Type			Type	F / R	Info	OEM		
77 01 475 841	Thread Measurement 1: M14x1,5 Thread Size 2: M14x1,5 Length: 293 mm with accessories			6186	6186			Thread Measurement 1: M14x1,5 Thread Size 2: M14x1,5 Length: 293 mm with accessories	77 01 475 841		
82 00 002 870	Length: 280 mm Thread Size: M10x1,5 Suspension Rod with accessories			5357	5357			Length: 280 mm Thread Size: M10x1,5 Suspension Rod with accessories	82 00 002 870		
82 00 127 308	Length: 248 mm Thread Size: M10x1,5 Coupling Rod without accessories			5353	5353			Length: 248 mm Thread Size: M10x1,5 Coupling Rod without accessories	82 00 127 308		
82 00 265 217	Length: 169,5 mm Thread Size: M12x1,25 Suspension Rod			5403	5403			Length: 169,5 mm Thread Size: M12x1,25 Suspension Rod	82 00 265 217		
77 01 475 842	with internal thread Thread Size: M14x1,5, M10x1,25			3349	3350			with internal thread Thread Size: M14x1,5, M10x1,25	77 01 475 843		
77 01 474 795	Inner Thread: M14x1,5mm Thread Size: M10x1,25 with accessories			3407	3408			Inner Thread: M14x1,5mm Thread Size: M10x1,25 with accessories	77 01 474 796		
82 00 298 454	for control arm			4062	4062			for control arm	82 00 298 454		
82 00 346 941	Control Arm			1472	1473			Control Arm	82 00 346 942		
82 00 183 569	for control arm			2277	2277			for control arm	82 00 183 569		
82 00 183 570	for control arm			2278	2278			for control arm	82 00 183 570		

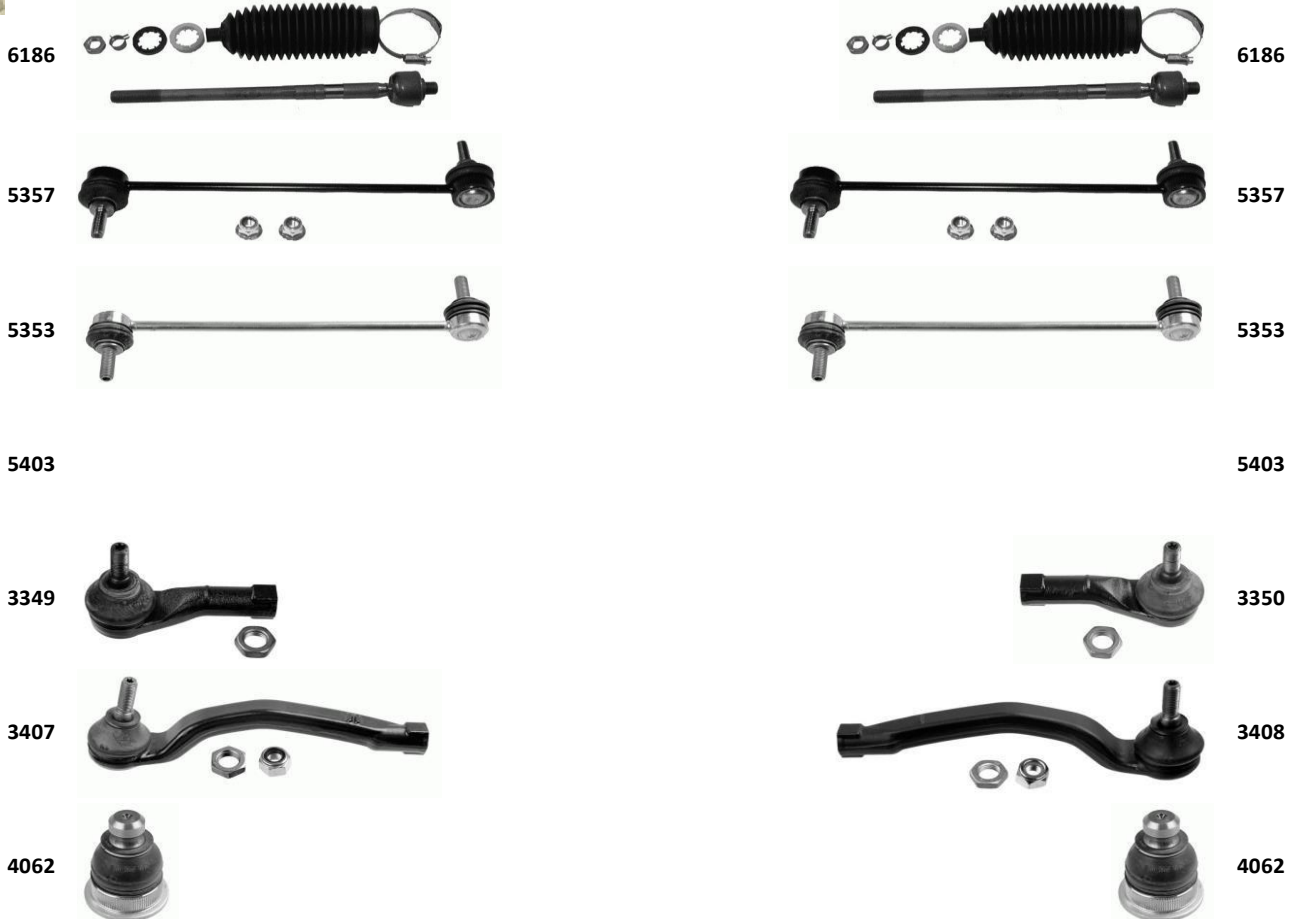

# RENAULT

CLIO III

























12.1999 - 08.2015



ESPACE I (J11_)				07.1984 - 12.1992				
OEM	Info	F / R	Type	Type	F / R	Info	OEM	
77 01 461 141	with accessories with right-hand thread Outer Thread 1: M14x1,5 mm Outer Thread: M10x1,5 mm			3400	3400		with accessories with right-hand thread Outer Thread 1: M14x1,5 mm Outer Thread: M10x1,5 mm	77 01 461 141
77 00 781 463	Thickness/Strength: 10,0 mm Inner Diameter: 36 mm Thread Size: M10x1,5 for control arm			2323	2323		Thickness/Strength: 10,0 mm Inner Diameter: 36 mm Thread Size: M10x1,5 for control arm	77 00 781 463
77 00 822 503	Mounting Type: Rubber-metal Bearing			2324	2324		Mounting Type: Rubber-metal Bearing	77 00 822 503
60 25 311 529	Mounting Type: Rubber-metal Bearing for control arm			2325	2325		Mounting Type: Rubber-metal Bearing for control arm	60 25 311 529



# RENAULT

ESPACE II (J/S63_)						01.1991 - 12.1996			
OEM	Info	F / R	Type			Type	F / R	Info	OEM
77 01 464 313	Length: 173,5 mm with accessories			6356	6356			Length: 173,5 mm with accessories	77 01 464 313
77 01 464 313	with accessories			11143	11143			with accessories	77 01 464 313
77 01 461 141	with accessories with right-hand thread Outer Thread 1: M14x1,5 mm Outer Thread: M10x1,5 mm			3400	3400			with accessories with right-hand thread Outer Thread 1: M14x1,5 mm Outer Thread: M10x1,5 mm	77 01 461 141
77 00 781 463	Thickness/Strength: 10,0 mm Inner Diameter: 36 mm Thread Size: M10x1,5 for control arm			2323	2323			Thickness/Strength: 10,0 mm Inner Diameter: 36 mm Thread Size: M10x1,5 for control arm	77 00 781 463
77 00 822 503	Mounting Type: Rubber-metal Bearing			2324	2324			Mounting Type: Rubber-metal Bearing	77 00 822 503
60 25 311 529	Mounting Type: Rubber-metal Bearing for control arm			2325	2325			Mounting Type: Rubber-metal Bearing for control arm	60 25 311 529



# RENAULT

ESPACE III (JEO_)				11.1996 - 02.2015					
OEM	Info	F / R	Type			Type	F / R	Info	OEM
60 25 370 493	Length: 234 mm Thread Size: M12x1,0 Outer Thread: M14x1,5 mm with accessories			6357	6357			Length: 234 mm Thread Size: M12x1,0 Outer Thread: M14x1,5 mm with accessories	60 25 370 493
60 25 370 493	with accessories			11144	11145			with accessories	60 25 370 494
77 00 805 494	Suspension Rod			5402	5402			Suspension Rod	77 00 805 494
60 00 022 762	Cone Size: 14,6 mm Length: 202 mm Inner Thread: M14x1,5 mm with right-hand thread			3402	3401			Cone Size: 14,6 mm Length: 202 mm Inner Thread: M14x1,5 mm with right-hand thread	60 00 022 761
60 25 308 155				4182	4182				60 25 308 155
60 25 305 572	Control Arm with ball joint, with rubber mounting			1470	1471			Control Arm with ball joint, with rubber mounting	60 25 305 573
77 00 822 503	Mounting Type: Rubber-metal Bearing			2324	2324			Mounting Type: Rubber-metal Bearing	77 00 822 503
60 25 311 529	Mounting Type: Rubber-metal Bearing for control arm			2325	2325			Mounting Type: Rubber-metal Bearing for control arm	60 25 311 529



6357



6357



11144



11145



5402



5402



3402



3401



4182



4182



1470



1471



2324



2324



2325



2325



# RENAULT

ESPACE IV (JK0/1_)								12.1899 - 02.2015	
OEM	Info	F / R	Type			Type	F / R	Info	OEM
77 01 474 076	Thread Measurement 1: M12x1,0 Thread Size 2: M14x1,5 Length: 231 mm with accessories			6231	6231			Thread Measurement 1: M12x1,0 Thread Size 2: M14x1,5 Length: 231 mm with accessories	77 01 474 076
82 00 002 870	Length: 280 mm Thread Size: M10x1,5 Suspension Rod with accessories			5357	5357			Length: 280 mm Thread Size: M10x1,5 Suspension Rod with accessories	82 00 002 870
77 01 049 282				3549	3359				77 01 049 283
60 40 002 105	Cone Size: 19,55 mm Bore $\varnothing$ : 10 mm with accessories			4160	4160			Cone Size: 19,55 mm Bore $\varnothing$ : 10 mm with accessories	60 40 002 105
82 00 002 869				2279	2279				82 00 002 869
82 00 002 868	Mounting Type: Rubber-metal Bearing			2329	2329			Mounting Type: Rubber-metal Bearing	82 00 002 868

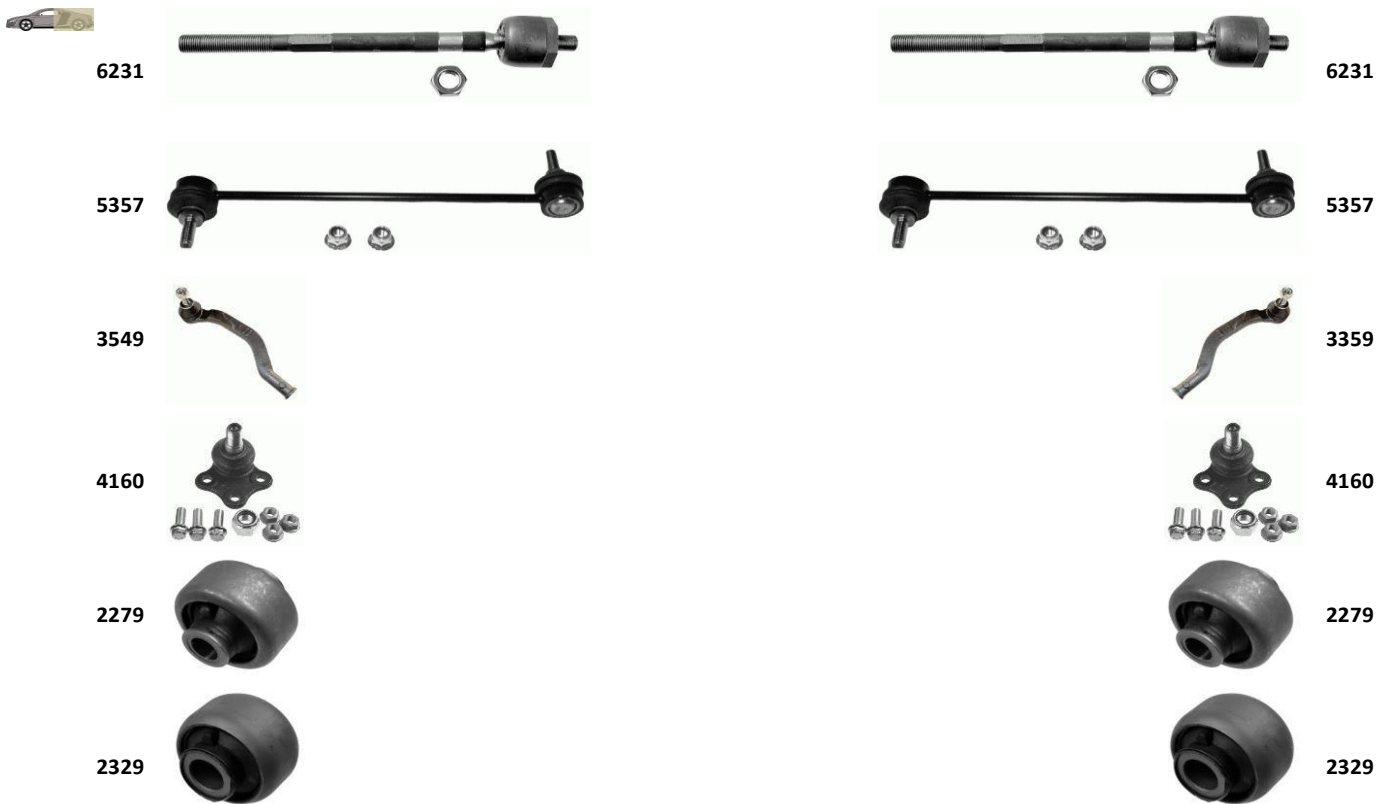

FLUENCE (L30_)								12.1899 - 10.2015	
OEM	Info	F / R	Type			Type	F / R	Info	OEM
48 52 156 12R	Thread Size: M14x1,5 Length: 200 mm			6232	6232			Thread Size: M14x1,5 Length: 200 mm	48 52 156 12R
48 52 027 10R	Cone Size: 14,9 mm Inner Thread: M14x1,5 mm Outer Thread: M10x1,25 mm Length: 210,5 mm			3409	3410			Cone Size: 14,9 mm Inner Thread: M14x1,5 mm Outer Thread: M10x1,25 mm Length: 210,5 mm	48 52 046 80R
40 16 090 60R	Outer Thread: M12x1,25 mm Cone Size: 21,2 mm			4185	4185			Outer Thread: M12x1,25 mm Cone Size: 21,2 mm	40 16 090 60R

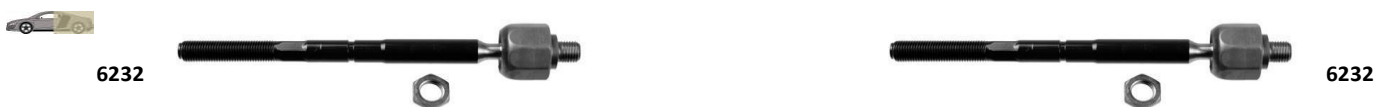

# RENAULT

FLUENCE (L30\_)

12.1899 - 10.2015



3409



3410



4185



4185

FUEGO (136\_)

02.1980 - 11.1992

OEM	Info	F / R	Type			Type	F / R	Info	OEM
77 01 461 141	with accessories with right-hand thread Outer Thread 1: M14x1,5 mm Outer Thread: M10x1,5 mm			3400	3400			with accessories with right-hand thread Outer Thread 1: M14x1,5 mm Outer Thread: M10x1,5 mm	77 01 461 141



3400



3400

GRAND SCÉNIC II (JM0/1\_)

12.1899 - 04.2015

OEM	Info	F / R	Type			Type	F / R	Info	OEM
77 01 474 448	Length: 196 mm Thread Measurement 1: M14x1,5 Thread Size 2: M14x1,5 with accessories			6359	6359			Length: 196 mm Thread Measurement 1: M14x1,5 Thread Size 2: M14x1,5 with accessories	77 01 474 448
82 00 166 159	Suspension Rod Steel with accessories			5404	5404			Suspension Rod Steel with accessories	82 00 166 159
77 01 474 795	Inner Thread: M14x1,5mm Thread Size: M10x1,25 with accessories			3407	3408			Inner Thread: M14x1,5mm Thread Size: M10x1,25 with accessories	77 01 474 796
82 00 298 454	for control arm			4062	4062			for control arm	82 00 298 454
82 00 298 454	Cone Size: 18 mm Control Arm			1478	1479			Cone Size: 18 mm Control Arm	82 00 298 455
82 00 242 025	Mounting Type: Rubber-metal Bearing for control arm			2330	2330			Mounting Type: Rubber-metal Bearing for control arm	82 00 242 025
82 00 041 166	Mounting Type: Rubber-metal Bearing for control arm			2331	2331			Mounting Type: Rubber-metal Bearing for control arm	82 00 041 166



6359



6359



5404



5404

# RENAULT

GRAND SCÉNIC II (JM0/1\_)

12.1899 - 04.2015



3408



4062



1479



2330



2331

GRAND SCÉNIC III (JZ0/1\_)

12.1899 - 09.2015

OEM	Info	F / R	Type			Type	F / R	Info	OEM
48 52 156 12R	Thread Size: M14x1,5 Length: 200 mm			6232	6232			Thread Size: M14x1,5 Length: 200 mm	48 52 156 12R
48 52 027 10R	Cone Size: 14,9 mm Inner Thread: M14x1,5 mm Outer Thread: M10x1,25 mm Length: 210,5 mm			3409	3410			Cone Size: 14,9 mm Inner Thread: M14x1,5 mm Outer Thread: M10x1,25 mm Length: 210,5 mm	48 52 046 80R
40 16 090 60R	Outer Thread: M12x1,25 mm Cone Size: 21,2 mm			4185	4185			Outer Thread: M12x1,25 mm Cone Size: 21,2 mm	40 16 090 60R



6232



3410



4185

# RENAULT

KANGOO (KC0/1_, FC0/1_)						12.1899 - 08.1997			
OEM	Info	F / R	Type			Type	F / R	Info	OEM
77 01 470 764	Length: 245 mm			6360	6360			Length: 245 mm	77 01 470 764
77 01 470 763	with accessories			6361	6361			with accessories	77 01 470 763
77 01 472 120	Length: 282 mm Thread Measurement 1: M12x1,0 Thread Size 2: M14x1,5 with accessories for vehicles with power steering			6340	6340			Length: 282 mm Thread Measurement 1: M12x1,0 Thread Size 2: M14x1,5 with accessories for vehicles with power steering	77 01 472 120
77 01 472 113	Length: 302 mm Outer Thread: M12x1,0 mm, M14x1,5 mm with accessories			6341	6341			Length: 302 mm Outer Thread: M12x1,0 mm, M14x1,5 mm with accessories	77 01 472 113
77 00 799 404	Coupling Rod			5352	5352			Coupling Rod	77 00 799 404
82 00 603 492	Suspension Rod			5405	5405			Suspension Rod	82 00 603 492
60 00 022 752				3412	3411				60 00 022 753
77 01 047 415	with accessories Cone Size: 14,6 mm Thread Size: M10x1,25 Inner Thread: M14x1,5 mm			3346	3347			with accessories Cone Size: 14,6 mm Thread Size: M10x1,25 Inner Thread: M14x1,5 mm	77 01 047 416
77 01 472 038	Total Length: 124 mm Thickness/Strength: 16 mm Thread Size: M10 with fastening material			4181	4181			Total Length: 124 mm Thickness/Strength: 16 mm Thread Size: M10 with fastening material	77 01 472 038
82 00 681 176	Thickness/Strength: 18 mm Bore Ø: 12 mm Thread Size: M12 with fastening material			4184	4184			Thickness/Strength: 18 mm Bore Ø: 12 mm Thread Size: M12 with fastening material	82 00 681 176
77 00 425 227	Control Arm with ball joint, with rubber mounting Sheet Steel			1476	1477			Control Arm with ball joint, with rubber mounting Sheet Steel	77 00 425 228
77 00 424 399	Mounting Type: Rubber-metal Bearing for control arm			2328	2328			Mounting Type: Rubber-metal Bearing for control arm	77 00 424 399

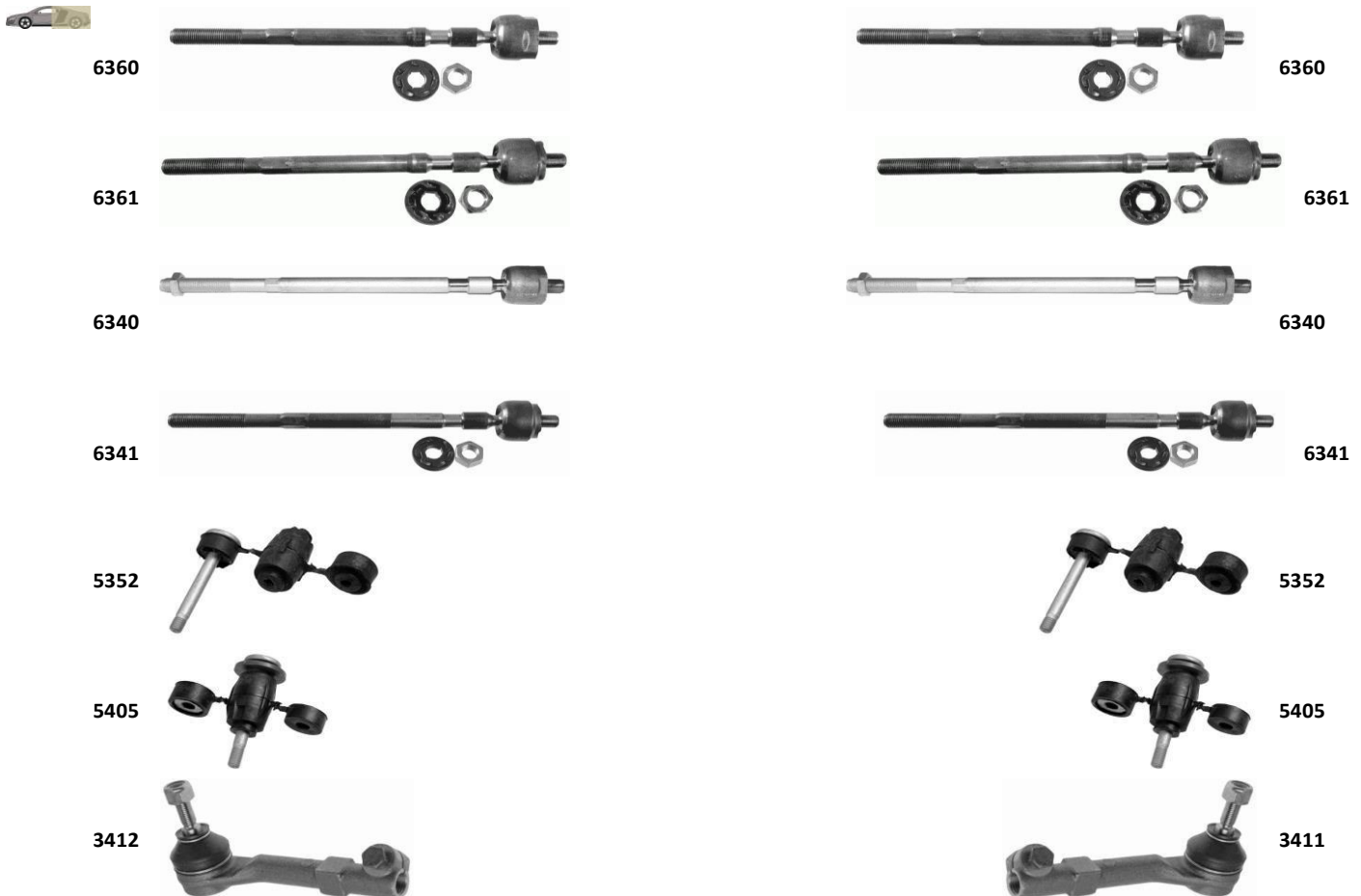



# RENAULT

KANGOO (KC0/1\_, FC0/1\_)

12.1899 - 08.1997



KANGOO (KW0/1\_, FW0/1\_)

12.1899 - 08.2015

OEM	Info	F / R	Type			Type	F / R	Info	OEM
48 52 156 12R	Thread Size: M14x1,5 Length: 200 mm			6232	6232			Thread Size: M14x1,5 Length: 200 mm	48 52 156 12R
82 00 166 159	Suspension Rod Steel with accessories			5404	5404			Suspension Rod Steel with accessories	82 00 166 159
77 01 478 407	Inner Thread: M14x1,5 mm Outer Thread: M10x1,25 mm			3413	3414			Inner Thread: M14x1,5 mm Outer Thread: M10x1,25 mm	77 01 478 408
82 00 586 561	Cone Size: 20 mm			4186	4187			Cone Size: 20 mm	82 00 586 567
82 00 586 561	for control arm			2332	2333			for control arm	82 00 586 561



# RENAULT

KOLEOS (HY\_)

12.1899 - 08.2015

2332



2333



KOLEOS (HY\_)

12.1899 - 08.2015

OEM	Info	F / R	Type			Type	F / R	Info	OEM
D8 52 1JG 00A				6190	6190				D8 52 1JG 00A
55 66 8JD 00A				5355	5356				54 61 8JD 00A
54500-JY00A				4164	4164				54500-JY00A



6190



6190



5355



5356



4164



4164



LAGUNA I (B56\_ , 556\_ , K56\_)

09.1995 - 01.2015

OEM	Info	F / R	Type			Type	F / R	Info	OEM
60 00 022 819	with accessories Thread Measurement 1: M12x1,0 Thread Size 2: M14x1,5 Length: 250 mm			6237	6237			with accessories Thread Measurement 1: M12x1,0 Thread Size 2: M14x1,5 Length: 250 mm	60 00 022 819
77 01 467 501	with accessories			11146	11147			with accessories	77 01 467 502
77 00 805 494	Suspension Rod			5402	5402			Suspension Rod	77 00 805 494
60 00 022 737	Inner Thread: M14x1,5 mm			3417	3418			Inner Thread: M14x1,5 mm	60 00 022 736
77 00 418 693				4189	4189				77 00 418 693
77 00 413 493	Control Arm Steel			1481	1480			Control Arm Steel	77 00 413 494
77 00 822 503	Mounting Type: Rubber-metal Bearing			2324	2324			Mounting Type: Rubber-metal Bearing	77 00 822 503
77 00 824 042	Mounting Type: Rubber-metal Bearing			2334	2334			Mounting Type: Rubber-metal Bearing	77 00 824 042



6237



6237



11146



11147



5402



5402



# RENAULT

LAGUNA I (B56\_, 556\_, K56\_)

09.1995 - 01.2015

3417

3418

4189

4189

1481

1480

2324

2324

2334

2334



LAGUNA II (BG0/1_, KG0/1_)				12.1899 - 01.2015					
OEM	Info	F / R	Type			Type	F / R	Info	OEM
77 01 472 766	with accessories			6238	6238			with accessories	77 01 472 766
82 00 002 870	Length: 280 mm Thread Size: M10x1,5 Suspension Rod with accessories			5357	5357			Length: 280 mm Thread Size: M10x1,5 Suspension Rod with accessories	82 00 002 870
77 01 049 282				3549	3359				77 01 049 283
60 40 002 105	Cone Size: 19,55 mm Bore Ø: 10 mm with accessories			4160	4160			Cone Size: 19,55 mm Bore Ø: 10 mm with accessories	60 40 002 105
80 00 273 728	Control Arm with rubber mounting, with ball joint Sheet Steel			1596	1597			Control Arm with rubber mounting, with ball joint Sheet Steel	82 00 026 655
82 00 002 869				2279	2279				82 00 002 869
82 00 002 868	Mounting Type: Rubber-metal Bearing			2329	2329			Mounting Type: Rubber-metal Bearing	82 00 002 868



6238



6238



5357



5357



3549



3359



# RENAULT

LAGUNA II (BG0/1\_, KG0/1\_)

12.1899 - 01.2015



LAGUNA III (BT0/1, KT0/1, DT0/1)					12.1899 - 08.2015				
OEM	Info	F / R	Type			Type	F / R	Info	OEM
48 52 100 01R	Thread Size: M14x1,5 Length: 166,5 mm			6236	6236			Thread Size: M14x1,5 Length: 166,5 mm	48 52 100 01R
54 61 800 01R	Length: 294 mm Thread Size: M10x1,5 Suspension Rod			5406	5406			Length: 294 mm Thread Size: M10x1,5 Suspension Rod	54 61 800 01R
48 52 000 01R	Inner Thread: M14x1,5 mm Outer Thread: M12x1,25 mm Length: 240 mm Cone Size: 19 mm			3415	3416			Inner Thread: M14X1,5 mm Outer Thread: M12X1,25 mm Length: 240 mm Cone Size: 19 mm	48 52 000 02R
40 16 000 04R	Cone Size: 23 mm Outer Thread: M12x1,25 mm			4188	4188			Cone Size: 23 mm Outer Thread: M12x1,25 mm	40 16 000 04R



# RENAULT

MASTER I								07.1980 - 07.1998	
OEM	Info	F / R	Type			Type	F / R	Info	OEM
77 00 302 165	Suspension Rod with accessories			5350	5351			Suspension Rod with accessories	77 00 307 343
77 01 462 427	with right-hand thread Inner Thread: M16x1,5 mm			3419	3419			with right-hand thread Inner Thread: M16x1,5 mm	77 01 462 427



5350



5351



3419



3419



MASTER II								12.1999 - 07.1998	
OEM	Info	F / R	Type			Type	F / R	Info	OEM
77 01 470 362	Length: 150 mm Thread Size: M14x1,5, M16x1,5 with accessories			6183	6183			Length: 150 mm Thread Size: M14x1,5, M16x1,5 with accessories	77 01 470 362
77 00 302 165	Suspension Rod with accessories			5350	5351			Suspension Rod with accessories	77 00 307 343
77 01 470 363				3344	3345				77 01 470 364
77 00 312 851	with accessories			4246	4246			with accessories	77 00 312 851
77 00 312 852	with accessories			4247	4247			with accessories	77 00 312 852
77 00 302 114				4154	4154				77 00 302 114
77 01 070 154	with accessories			4248	4248			with accessories	77 01 070 154
77 00 309 189				1417	1418				77 00 309 190
77 00 302 122				2275	2275				77 00 302 122
77 00 302 123				2276	2276				77 00 302 123



6183



6183



5350



5351



3344



3345



4246



4246



4247



4247



4154



4154



# RENAULT

## MASTER II

12.1899 - 07.1998



MASTER III				12.1899 - 10.2015					
OEM	Info	F / R	Type			Type	F / R	Info	OEM
54 61 800 04R	Length: 330 mm Thread Size: M10x1,5 Suspension Rod			5381	5381			Length: 330 mm Thread Size: M10x1,5 Suspension Rod	54 61 800 04R
48 52 067 30R	Vertical Thread Size: M14x1,5 Inner Thread: M18x1,5 mm			3377	3378			Vertical Thread Size: M14x1,5 Inner Thread: M18x1,5 mm	48 52 007 80R
82 00 688 877	Cone Size: 23 mm Thread Size: M16x1,5			4173	4173			Cone Size: 23 mm Thread Size: M16x1,5	82 00 688 877
82 00 688 832	Inner Diameter: 16,2 mm Outer Diameter: 49,7 mm Length: 64,1 mm			2300	2300			Inner Diameter: 16,2 mm Outer Diameter: 49,7 mm Length: 64,1 mm	82 00 688 832
54 56 011 73R	Inner Diameter: 16,2 mm Outer Diameter: 70 mm Length: 77 mm			2301	2301			Inner Diameter: 16,2 mm Outer Diameter: 70 mm Length: 77 mm	54 56 011 73R



2300



2301



2300



2301



# RENAULT

MEGANE I (BA0/1_, DAO/1_, EA0/1_, JAO/1_, LA0/1_) 03.1996 - 03.2015									
OEM	Info	F / R	Type			Type	F / R	Info	OEM
77 01 472 087	Manufacturer Restriction: TRW Length: 270 mm Outer Thread: M14x1,5 mm with accessories			6239	6239			Manufacturer Restriction: TRW Length: 270 mm Outer Thread: M14x1,5 mm with accessories	77 01 472 087
77 01 469 502	Manufacturer Restriction: SMI with accessories Length: 244 mm			6240	6240			Manufacturer Restriction: SMI with accessories Length: 244 mm	77 01 469 502
60 00 022 819	with accessories Thread Measurement 1: M12x1,0 Thread Size 2: M14x1,5 Length: 250 mm			6237	6237			with accessories Thread Measurement 1: M12x1,0 Thread Size 2: M14x1,5 Length: 250 mm	60 00 022 819
77 01 471 885	with accessories			6241	6241			with accessories	77 01 471 885
77 01 469 280	Manufacturer Restriction: TRW with accessories Thread Size: M14x1,5 Length: 240 mm			6242	6242			Manufacturer Restriction: TRW with accessories Thread Size: M14x1,5 Length: 240 mm	77 01 469 280
77 01 471 844	Manufacturer Restriction: SMI Length: 274 mm Thread Measurement 1: M12x1,0 Thread Size 2: M14x1,5 with accessories			6243	6243			Manufacturer Restriction: SMI Length: 274 mm Thread Measurement 1: M12x1,0 Thread Size 2: M14x1,5 with accessories	77 01 471 844
77 00 847 382	Suspension Rod			5407	5407			Suspension Rod	77 00 847 382
60 00 022 752				3412	3411				60 00 022 753
77 01 047 415	with accessories Cone Size: 14,6 mm Thread Size: M10x1,25 Inner Thread: M14x1,5 mm			3346	3347			with accessories Cone Size: 14,6 mm Thread Size: M10x1,25 Inner Thread: M14x1,5 mm	77 01 047 416
77 01 472 038	Total Length: 124 mm Thickness/Strength: 16 mm Thread Size: M10 with fastening material			4181	4181			Total Length: 124 mm Thickness/Strength: 16 mm Thread Size: M10 with fastening material	77 01 472 038
77 00 436 302	Control Arm Sheet Steel			1468	1469			Control Arm Sheet Steel	77 00 436 303
77 00 430 831	Control Arm Sheet Steel for supporting joint with screw M12			1484	1485			Control Arm Sheet Steel for supporting joint with screw M12	77 00 430 832
77 00 425 724	Control Arm with ball joint, with rubber mounting Sheet Steel			1598	1599			Control Arm with ball joint, with rubber mounting Sheet Steel	77 00 425 725
77 00 789 478	Mounting Type: Rubber-metal Bearing			2320	2320			Mounting Type: Rubber-metal Bearing	77 00 789 478
77 00 789 477				2321	2321				77 00 789 477







# RENAULT

MEGANE II (BMO/1_, CM0/1_, KM0/1_, LM0/1_)								12.1899 - 02.2015	
OEM	Info	F / R	Type			Type	F / R	Info	OEM
77 01 474 448	Length: 196 mm Thread Measurement 1: M14x1,5 Thread Size 2: M14x1,5 with accessories			6359	6359			Length: 196 mm Thread Measurement 1: M14x1,5 Thread Size 2: M14x1,5 with accessories	77 01 474 448
82 00 166 159	Suspension Rod Steel with accessories			5404	5404			Suspension Rod Steel with accessories	82 00 166 159
82 00 166 160	Suspension Rod Steel for vehicles with increased ground clearance Length: 266,5 mm with accessories Thread Size: M10x1,5 Pipe Ø: 9,0 mm			5408	5408			Suspension Rod Steel for vehicles with increased ground clearance Length: 266,5 mm with accessories Thread Size: M10x1,5 Pipe Ø: 9,0 mm	82 00 166 160
82 00 265 217	Length: 169,5 mm Thread Size: M12x1,25 Suspension Rod			5403	5403			Length: 169,5 mm Thread Size: M12x1,25 Suspension Rod	82 00 265 217
77 01 474 795	Inner Thread: M14x1,5 mm Thread Size: M10x1,25 with accessories			3407	3408			Inner Thread: M14x1,5 mm Thread Size: M10x1,25 with accessories	77 01 474 796
82 00 298 454	for control arm			4062	4062			for control arm	82 00 298 454
82 00 298 454	Cone Size: 18 mm Control Arm			1478	1479			Cone Size: 18 mm Control Arm	82 00 298 455
82 00 002 869				2279	2279				82 00 002 869
82 00 242 025	Mounting Type: Rubber-metal Bearing for control arm			2330	2330			Mounting Type: Rubber-metal Bearing for control arm	82 00 242 025
82 00 041 166	Mounting Type: Rubber-metal Bearing for control arm			2331	2331			Mounting Type: Rubber-metal Bearing for control arm	82 00 041 166



# RENAULT

MEGANE III (BZO\_/DZO/1\_, EZO/1\_, KZO/1)

12.1899 - 08.2015

MEGANE II (BMO/1\_, CMO/1\_, KMO/1\_, LMO/1\_)

12.1899 - 02.2015



MEGANE III (BZO\_/DZO/1\_, EZO/1\_, KZO/1)

12.1899 - 08.2015

OEM	Info	F / R	Type			Type	F / R	Info	OEM
48 52 156 12R	Thread Size: M14x1,5 Length: 200 mm			6232	6232			Thread Size: M14x1,5 Length: 200 mm	48 52 156 12R
48 52 027 10R	Cone Size: 14,9 mm Inner Thread: M14x1,5 mm Outer Thread: M10x1,25 mm Length: 210,5 mm			3409	3410			Cone Size: 14,9 mm Inner Thread: M14x1,5 mm Outer Thread: M10x1,25 mm Length: 210,5 mm	48 52 046 80R
40 16 090 60R	Outer Thread: M12x1,25 mm Cone Size: 21,2 mm			4185	4185			Outer Thread: M12x1,25 mm Cone Size: 21,2 mm	40 16 090 60R



# RENAULT

MEGANE Scenic (JA0/1_)							10.1996 - 10.1999		
OEM	Info	F / R	Type			Type	F / R	Info	OEM
77 01 471 885	with accessories			6241	6241			with accessories	77 01 471 885
77 01 471 844	Manufacturer Restriction: SMI Length: 274 mm Thread Measurement 1: M12x1,0 Thread Size 2: M14x1,5 with accessories			6243	6243			Manufacturer Restriction: SMI Length: 274 mm Thread Measurement 1: M12x1,0 Thread Size 2: M14x1,5 with accessories	77 01 471 844
77 01 469 502	Manufacturer Restriction: SMI with accessories Length: 244 mm			6240	6240			Manufacturer Restriction: SMI with accessories Length: 244 mm	77 01 469 502
77 00 847 382	Suspension Rod			5407	5407			Suspension Rod	77 00 847 382
60 00 022 752				3412	3411				60 00 022 753
77 01 047 415	with accessories Cone Size: 14,6 mm Thread Size: M10x1,25 Inner Thread: M14x1,5 mm			3346	3347			with accessories Cone Size: 14,6 mm Thread Size: M10x1,25 Inner Thread: M14x1,5 mm	77 01 047 416
77 01 472 038	Total Length: 124 mm Thickness/Strength: 16 mm Thread Size: M10 with fastening material			4181	4181			Total Length: 124 mm Thickness/Strength: 16 mm Thread Size: M10 with fastening material	77 01 472 038
77 00 430 831	Control Arm Sheet Steel for supporting joint with screw M12			1484	1485			Control Arm Sheet Steel for supporting joint with screw M12	77 00 430 832
77 00 425 724	Control Arm with ball joint, with rubber mounting Sheet Steel			1598	1599			Control Arm with ball joint, with rubber mounting Sheet Steel	77 00 425 725



6241



6241



6243



6243



6240



6240



5407



5407



3412



3411



3346



3347



# RENAULT

MEGANE Scenic (JA0/1\_)

10.1996 - 10.1999



MODUS / GRAND MODUS (F/JP0_)						12.1899 - 04.2015				
OEM	Info	F / R	Type			Type	F / R	Info	OEM	
77 01 475 841	Thread Measurement 1: M14x1,5 Thread Size 2: M14x1,5 Length: 293 mm with accessories			6186	6186			Thread Measurement 1: M14x1,5 Thread Size 2: M14x1,5 Length: 293 mm with accessories	77 01 475 841	
82 00 127 308	Length: 248 mm Thread Size: M10x1,5 Coupling Rod without accessories			5353	5353			Length: 248 mm Thread Size: M10x1,5 Coupling Rod without accessories	82 00 127 308	
77 01 475 842	with internal thread Thread Size: M14x1,5, M10x1,25			3349	3350			with internal thread Thread Size: M14x1,5, M10x1,25	77 01 475 843	
82 00 298 454	for control arm			4062	4062			for control arm	82 00 298 454	
82 00 346 941	Control Arm			1472	1473			Control Arm	82 00 346 942	
82 00 183 569	for control arm			2277	2277			for control arm	82 00 183 569	
82 00 183 570	for control arm			2278	2278			for control arm	82 00 183 570	



# RENAULT

RAPID Box (F40\_, G40\_)

07.1985 - 11.1998

2278



2278



RAPID Box (F40_, G40_)				07.1985 - 11.1998					
OEM	Info	F / R	Type			Type	F / R	Info	OEM
77 01 465 915	with accessories for OE No.: 77 01 465 915			6222	6222			with accessories for OE No.: 77 01 465 915	77 01 465 915
77 01 463 346	with accessories			11148	11148			with accessories	77 01 463 346
77 01 461 141	with accessories with right-hand thread Outer Thread 1: M14x1,5 mm Outer Thread: M10x1,5 mm			3400	3400			with accessories with right-hand thread Outer Thread 1: M14x1,5 mm Outer Thread: M10x1,5 mm	77 01 461 141
77 01 462 182	for vehicles without ABS Thread Size: M10 with fastening material			4180	4180			for vehicles without ABS Thread Size: M10 with fastening material	77 01 462 182
77 01 472 038	Total Length: 124 mm Thickness/Strength: 16 mm Thread Size: M10 with fastening material			4181	4181			Total Length: 124 mm Thickness/Strength: 16 mm Thread Size: M10 with fastening material	77 01 472 038
77 04 000 681	Thickness/Strength: 46,0 mm, 35,0 mm Inner Diameter: 12 mm Outer Diameter: 32 mm			2322	2322			Thickness/Strength: 46,0 mm, 35,0 mm Inner Diameter: 12 mm Outer Diameter: 32 mm	77 04 000 681



6222



6222



11148



11148



3400



3400



4180



4180



4181



4181



2322



2322







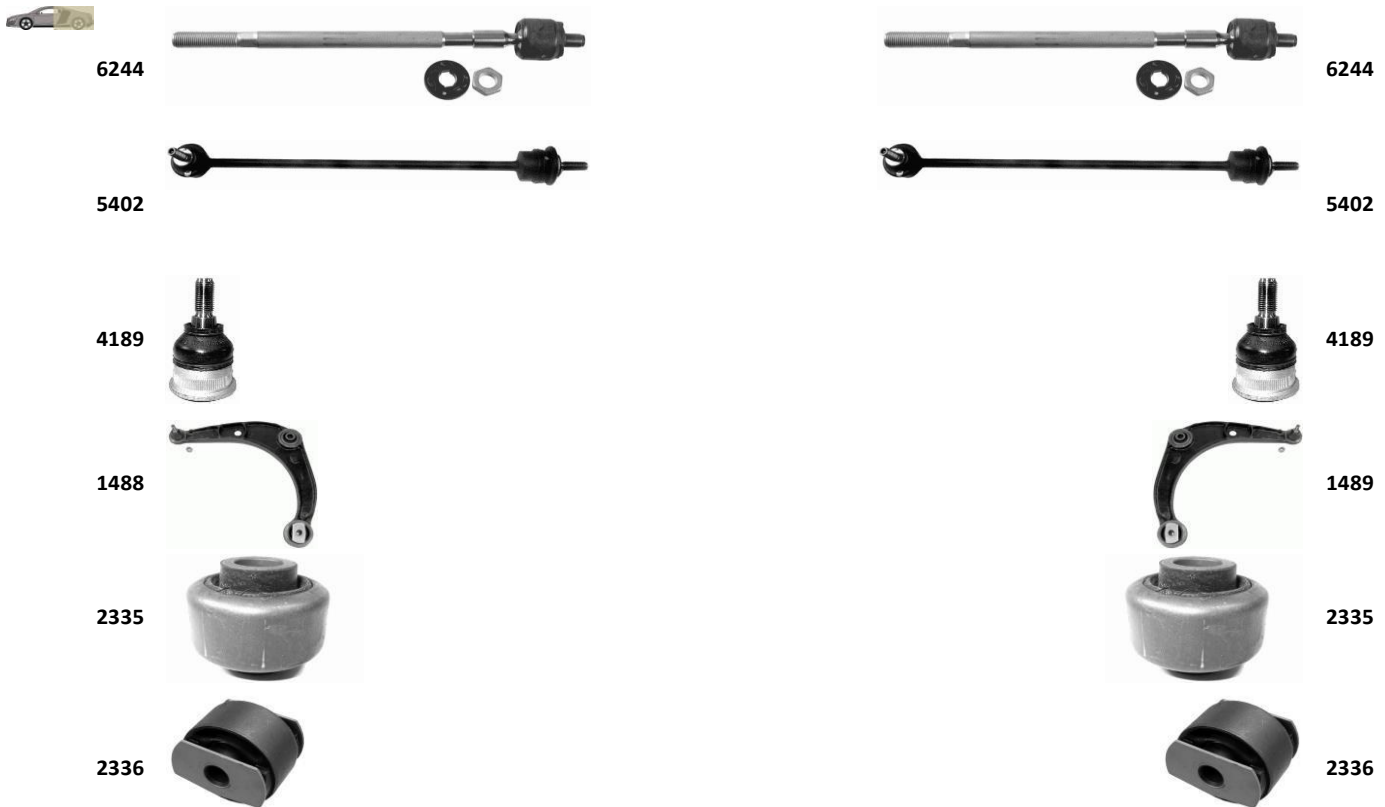











# RENAULT

SAFRANE I (B54_)						04.1992 - 10.1996			
OEM	Info	F / R	Type			Type	F / R	Info	OEM
60 00 022 825	for OE No.: 77 01 466 799/899 Manufacturer Restriction: SMI Axle Vers.: SMI with right-hand thread Outer Thread: M14x1,5 mm, M12x1,5 mm with accessories			6244	6244			for OE No.: 77 01 466 799/899 Manufacturer Restriction: SMI Axle Vers.: SMI with right-hand thread Outer Thread: M14x1,5 mm, M12x1,5 mm with accessories	60 00 022 825
77 00 805 494	Suspension Rod			5402	5402			Suspension Rod	77 00 805 494
77 00 418 693				4189	4189				77 00 418 693
77 00 807 580	Control Arm with ball joint, with rubber mounting Steel			1488	1489			Control Arm with ball joint, with rubber mounting Steel	77 00 807 581
77 00 806 239				2335	2335				77 00 806 239
77 00 806 238				2336	2336				77 00 806 238



# RENAULT

SAFRANE II (B54_)						07.1996 - 12.2000			
OEM	Info	F / R	Type			Type	F / R	Info	OEM
60 00 022 825	for OE No.: 77 01 466 799/899 Manufacturer Restriction: SMI Axle Vers.: SMI with right-hand thread Outer Thread: M14x1,5 mm, M12x1,5 mm with accessories			6244	6244			for OE No.: 77 01 466 799/899 Manufacturer Restriction: SMI Axle Vers.: SMI with right-hand thread Outer Thread: M14x1,5 mm, M12x1,5 mm with accessories	60 00 022 825
77 00 805 494	Suspension Rod			5402	5402			Suspension Rod	77 00 805 494
77 00 418 693				4189	4189				77 00 418 693
77 00 807 580	Control Arm with ball joint, with rubber mounting Steel			1488	1489			Control Arm with ball joint, with rubber mounting Steel	77 00 807 581



6244



6244



5402



5402



4189



4189



1488



























1489





# RENAULT

SCÉNIC I (JA0/1_)				09.1999 - 03.2015					
OEM	Info	F / R	Type			Type	F / R	Info	OEM
77 01 471 844	Manufacturer Restriction: SMI Length: 274 mm Thread Measurement 1: M12x1,0 Thread Size 2: M14x1,5 with accessories			<b>6243</b>	<b>6243</b>			Manufacturer Restriction: SMI Length: 274 mm Thread Measurement 1: M12x1,0 Thread Size 2: M14x1,5 with accessories	77 01 471 844
77 01 047 415	with accessories Cone Size: 14,6 mm Thread Size: M10x1,25 Inner Thread: M14x1,5 mm			<b>3346</b>	<b>3347</b>			with accessories Cone Size: 14,6 mm Thread Size: M10x1,25 Inner Thread: M14x1,5 mm	77 01 047 416
77 00 430 831	Control Arm Sheet Steel for supporting joint with screw M12			<b>1484</b>	<b>1485</b>			Control Arm Sheet Steel for supporting joint with screw M12	77 00 430 832
77 00 425 724	Control Arm with ball joint, with rubber mounting Sheet Steel			<b>1598</b>	<b>1599</b>			Control Arm with ball joint, with rubber mounting Sheet Steel	77 00 425 725
77 00 789 478	Mounting Type: Rubber-metal Bearing			<b>2320</b>	<b>2320</b>			Mounting Type: Rubber-metal Bearing	77 00 789 478
77 00 789 477				<b>2321</b>	<b>2321</b>				77 00 789 477



6243



6243



3346



3347



1484



1485



1598



1599



2320



2320



2321



2321



# RENAULT

SCÉNIC II (JMO/1_)				12.1899 - 03.2015					
OEM	Info	F / R	Type			Type	F / R	Info	OEM
77 01 474 448	Length: 196 mm Thread Measurement 1: M14x1,5 Thread Size 2: M14x1,5 with accessories			6359	6359			Length: 196 mm Thread Measurement 1: M14x1,5 Thread Size 2: M14x1,5 with accessories	77 01 474 448
82 00 166 159	Suspension Rod Steel with accessories			5404	5404			Suspension Rod Steel with accessories	82 00 166 159
77 01 474 795	Inner Thread: M14x1,5 mm Thread Size: M10x1,25 with accessories			3407	3408			Inner Thread: M14x1,5 mm Thread Size: M10x1,25 with accessories	77 01 474 796
82 00 298 454	for control arm			4062	4062			for control arm	82 00 298 454
82 00 298 454	Cone Size: 18 mm Control Arm			1478	1479			Cone Size: 18 mm Control Arm	82 00 298 455
82 00 242 025	Mounting Type: Rubber-metal Bearing for control arm			2330	2330			Mounting Type: Rubber-metal Bearing for control arm	82 00 242 025
82 00 041 166	Mounting Type: Rubber-metal Bearing for control arm			2331	2331			Mounting Type: Rubber-metal Bearing for control arm	82 00 041 166



# RENAULT

SCÉNIC III (JZ0/1_)				12.1899 - 09.2015					
OEM	Info	F / R	Type			Type	F / R	Info	OEM
48 52 156 12R	Thread Size: M14x1,5 Length: 200 mm			6232	6232			Thread Size: M14x1,5 Length: 200 mm	48 52 156 12R
48 52 027 10R	Cone Size: 14,9 mm Inner Thread: M14x1,5 mm Outer Thread: M10x1,25 mm Length: 210,5 mm			3409	3410			Cone Size: 14,9 mm Inner Thread: M14x1,5 mm Outer Thread: M10x1,25 mm Length: 210,5 mm	48 52 046 80R
40 16 090 60R	Outer Thread: M12x1,25 mm Cone Size: 21,2 mm			4185	4185			Outer Thread: M12x1,25 mm Cone Size: 21,2 mm	40 16 090 60R



SUPER 5 (B/C40_)				10.1984 - 12.1996					
OEM	Info	F / R	Type			Type	F / R	Info	OEM
77 01 465 915	with accessories for OE No.: 77 01 465 915			6222	6222			with accessories for OE No.: 77 01 465 915	77 01 465 915
77 01 463 346	with accessories			11148	11148			with accessories	77 01 463 346
77 01 461 141	with accessories with right-hand thread Outer Thread 1: M14x1,5 mm Outer Thread: M10x1,5 mm			3400	3400			with accessories with right-hand thread Outer Thread 1: M14x1,5 mm Outer Thread: M10x1,5 mm	77 01 461 141
77 01 462 182	for vehicles without ABS Thread Size: M10 with fastening material			4180	4180			for vehicles without ABS Thread Size: M10 with fastening material	77 01 462 182
77 01 472 038	Total Length: 124 mm Thickness/Strength: 16 mm Thread Size: M10 with fastening material			4181	4181			Total Length: 124 mm Thickness/Strength: 16 mm Thread Size: M10 with fastening material	77 01 472 038
77 04 000 681	Thickness/Strength: 46,0 mm, 35,0 mm Inner Diameter: 12 mm Outer Diameter: 32 mm			2322	2322			Thickness/Strength: 46,0 mm, 35,0 mm Inner Diameter: 12 mm Outer Diameter: 32 mm	77 04 000 681



# RENAULT

SUPER 5 (B/C40\_)

10.1984 - 12.1996

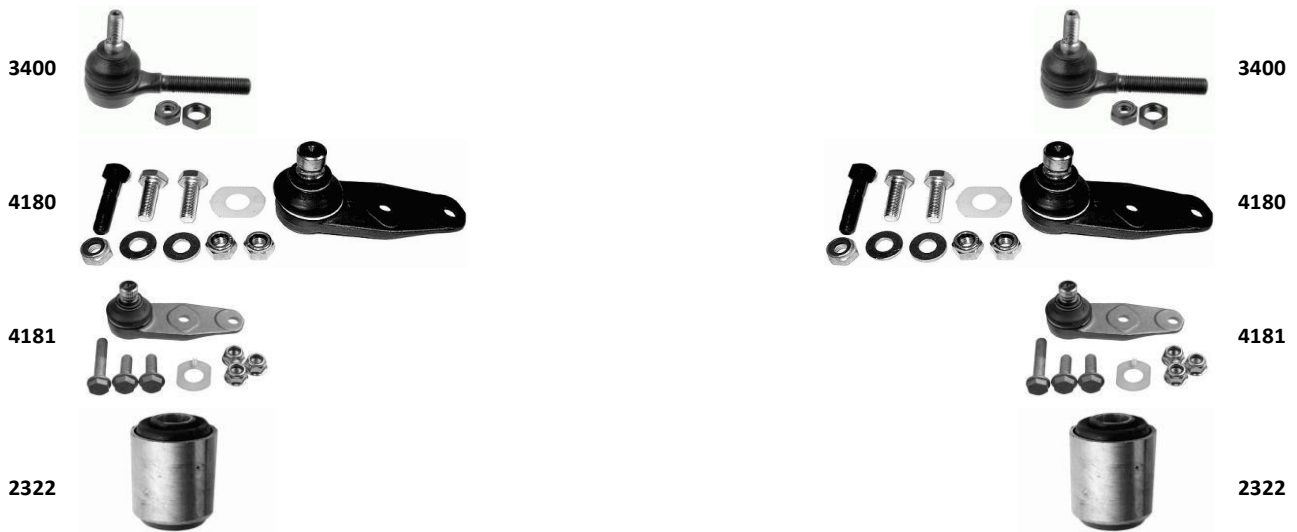

TRAFIC I								03.1980 - 04.1989	
OEM	Info	F / R	Type			Type	F / R	Info	OEM
77 01 463 035	Thread Measurement 1: M12x1,0 Thread Size 2: M14x1,5 Length: 273 mm with accessories			6245	6245			Thread Measurement 1: M12x1,0 Thread Size 2: M14x1,5 Length: 273 mm with accessories	77 01 463 035
77 01 461 769	with accessories			11149	11149			with accessories	77 01 461 769
77 01 461 770	with right-hand thread Outer Thread: M14x1,5 mm			3366	3366			with right-hand thread Outer Thread: M14x1,5 mm	77 01 461 770
77 01 349 064				2337	2337				77 01 349 064



# RENAULT

TRAFIC II								12.1899 - 01.2015	
OEM	Info	F / R	Type			Type	F / R	Info	OEM
77 01 473 333	Thread Measurement 1: M12x1,0 Thread Size 2: M14x1,5 Length: 245 mm			6187	6187			Thread Measurement 1: M12x1,0 Thread Size 2: M14x1,5 Length: 245 mm	77 01 473 333
82 00 002 870	Length: 280 mm Thread Size: M10x1,5 Suspension Rod with accessories			5357	5357			Length: 280 mm Thread Size: M10x1,5 Suspension Rod with accessories	82 00 002 870
77 01 049 282				3549	3359				77 01 049 283
60 40 002 105	Cone Size: 19,55 mm Bore Ø: 10 mm with accessories			4160	4160			Cone Size: 19,55 mm Bore Ø: 10 mm with accessories	60 40 002 105
77 01 477 385	Cone Size: 19,55 mm Bore Ø: 12 mm with accessories			4251	4251			Cone Size: 19,55 mm Bore Ø: 12 mm with accessories	77 01 477 385
82 00 054 003	Sheet Steel			1419	1420			Sheet Steel	82 00 054 006
82 00 395 007	Control Arm Cast Steel			1450	1451			Control Arm Cast Steel	82 00 395 034
82 00 002 869				2279	2279				82 00 002 869
82 00 049 624				2280	2280				82 00 049 624



6187



6187



5357



5357



3549



3359



4160



4160



4251



4251



1419



1420



1450



1451



2279



2279



# RENAULT

TWINGO (C06\_)

12.1899 - 03.1993

2280



2280



TWINGO (C06_)				12.1899 - 03.1993					
OEM	Info	F / R	Type			Type	F / R	Info	OEM
77 01 469 517	Thread Measurement 1: M12x1,0 Thread Size 2: M14x1,5 Length: 281 mm with accessories			6246	6246			Thread Measurement 1: M12x1,0 Thread Size 2: M14x1,5 Length: 281 mm with accessories	77 01 469 517
77 01 473 498	Thread Measurement 1: M12x1,0 Thread Size 2: M14x1,5 Length: 301 mm with accessories			6247	6247			Thread Measurement 1: M12x1,0 Thread Size 2: M14x1,5 Length: 301 mm with accessories	77 01 473 498
82 00 040 618	Length: 255 mm Thread Size: M10x1,5 Coupling Rod			5409	5410			Length: 255 mm Thread Size: M10x1,5 Coupling Rod	82 00 050 191
60 00 022 730	with right-hand thread Inner Thread: M14x1,5 mm			3420	3421			with right-hand thread Outer Thread: M10x1,25 mm	60 00 022 731
77 01 047 415	with accessories Cone Size: 14,6 mm Thread Size: M10x1,25 Inner Thread: M14x1,5 mm			3346	3347			with accessories Cone Size: 14,6 mm Thread Size: M10x1,25 Inner Thread: M14x1,5 mm	77 01 047 416
77 01 472 038	Total Length: 124 mm Thickness/Strength: 16 mm Thread Size: M10 with fastening material			4181	4181			Total Length: 124 mm Thickness/Strength: 16 mm Thread Size: M10 with fastening material	77 01 472 038
77 00 820 028	Control Arm with ball joint, with rubber mounting Sheet Steel			1491	1490			Control Arm Sheet Steel	77 00 820 029
77 00 819 928				2338	2338				77 00 819 928
77 00 819 929	Thickness/Strength: 46,0mm Inner Diameter: 12 mm Outer Diameter: 36 mm			2339	2339			Thickness/Strength: 46,0mm Inner Diameter: 12 mm Outer Diameter: 36 mm	77 00 819 929



6246



6246



6247



6247



5409



5410



3420



3421



3346



3347



4181



4181



# RENAULT

**TWINGO (C06\_)**

**12.1899 - 03.1993**



TWINGO (CNO_)				12.1899 - 07.2015					
OEM	Info	F / R	Type			Type	F / R	Info	OEM
77 01 477 878	Thread Measurement 1: M12x1,0 Thread Size 2: M14x1,5 Length: 285 mm			6248	6248			Thread Measurement 1: M12x1,0 Thread Size 2: M14x1,5 Length: 285 mm	77 01 477 878
82 00 603 492	Suspension Rod			5405	5405			Suspension Rod	82 00 603 492
77 01 047 415	with accessories Cone Size: 14,6 mm Thread Size: M10x1,25 Inner Thread: M14x1,5 mm			3346	3347			with accessories Cone Size: 14,6 mm Thread Size: M10x1,25 Inner Thread: M14x1,5 mm	77 01 047 416
82 00 681 176	Thickness/Strength: 18 mm Bore Ø: 12 mm Thread Size: M12 with fastening material			4184	4184			Thickness/Strength: 18 mm Bore Ø: 12 mm Thread Size: M12 with fastening material	82 00 681 176
77 00 424 399	Mounting Type: Rubber-metal Bearing for control arm			2328	2328			Mounting Type: Rubber-metal Bearing for control arm	77 00 424 399



# RENAULT

TWINGO (CNO\_)

12.1899 - 07.2015



VEL Satis (BJO_)				12.1899 - 02.2015					
OEM	Info	F / R	Type			Type	F / R	Info	OEM
77 01 474 076	Thread Measurement 1: M12x1,0 Thread Size 2: M14x1,5 Length: 231 mm with accessories			6231	6231			Thread Measurement 1: M12x1,0 Thread Size 2: M14x1,5 Length: 231 mm with accessories	77 01 474 076
82 00 002 870	Length: 280 mm Thread Size: M10x1,5 Suspension Rod with accessories			5357	5357			Length: 280 mm Thread Size: M10x1,5 Suspension Rod with accessories	82 00 002 870
77 01 049 282				3549	3359				77 01 049 283
60 40 002 105	Cone Size: 19,55 mm Bore $\varnothing$ : 10 mm with accessories			4160	4160			Cone Size: 19,55 mm Bore $\varnothing$ : 10 mm with accessories	60 40 002 105
82 00 002 869				2279	2279				82 00 002 869
82 00 002 868	Mounting Type: Rubber-metal Bearing			2329	2329			Mounting Type: Rubber-metal Bearing	82 00 002 868
82 00 001 857	Coupling Rod			5411	5411			Coupling Rod	82 00 001 857

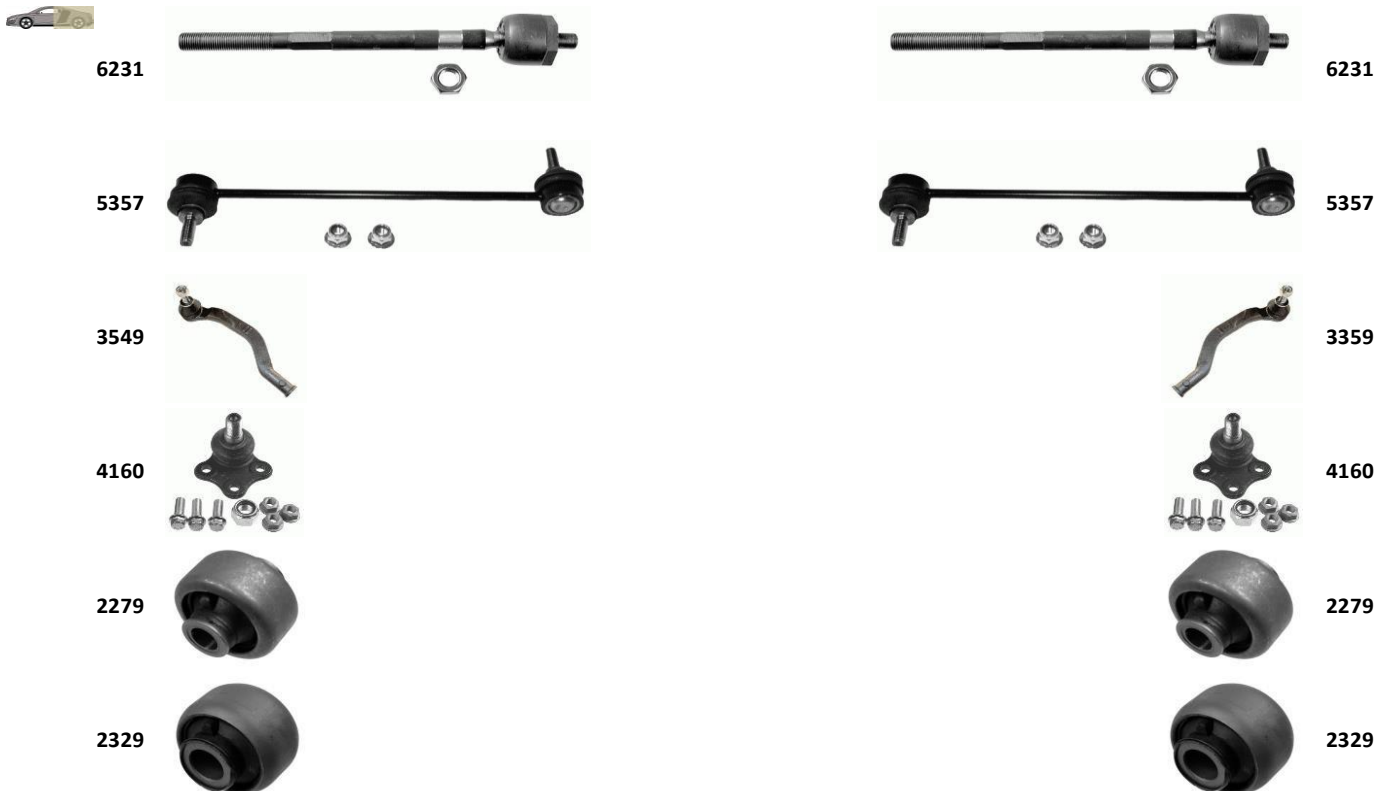



# RENAULT

**WIND (E4M\_) 12.1899 - 10.2015**



5411



5411

**WIND (E4M\_) 12.1899 - 10.2015**

OEM	Info	F / R	Type			Type	F / R	Info	OEM
77 01 047 415	with accessories Cone Size: 14,6 mm Thread Size: M10x1,25 Inner Thread: M14x1,5 mm			3346	3347			with accessories Cone Size: 14,6 mm Thread Size: M10x1,25 Inner Thread: M14x1,5 mm	77 01 047 416



3346



3347