

PEUGEOT

1007 (KM_)								-5,2015	
OEM	Info	F / R	Type			Type	F / R	Info	OEM
3812 E1	Outer Thread: M14x1,5 mm			6043	6043			Outer Thread: M14x1,5 mm	3812 E1
5087 45	Suspension Rod Steel with accessories			5105	5105			Suspension Rod Steel with accessories	5087 45
3817 55	Inner Thread: M14x1,5 mm			3101	3102			Inner Thread: M14x1,5 mm	3817 56
3640 59				4230	4230				3640 59

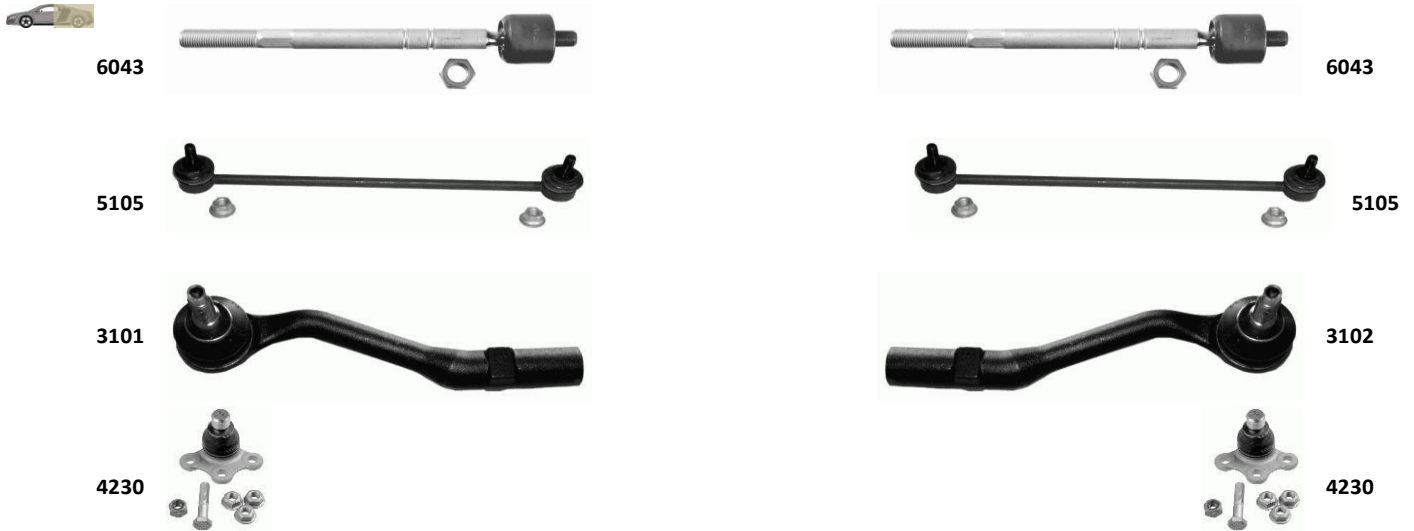

106 I (1A, 1C)								08.1991 - 04.1996	
5087 33	Suspension Rod			5455	5455			Suspension Rod	5087 33
3817 14	with right-hand thread Thread Size: M14x1,5			3092	3092			with right-hand thread Thread Size: M14x1,5	3817 14
3817 16	with right-hand thread Outer Thread: M14x1,5 mm			3093	3093			with right-hand thread Outer Thread: M14x1,5 mm	3817 16
3640 36	with accessories			4042	4042			with accessories	3640 36
3520 92	Control Arm Steel			1187	1186			Control Arm Steel	3520 93
3520 78	Control Arm with rubber mounting with accessories Steel			1184	1185			Control Arm with rubber mounting with accessories Steel	3520 79
3523 52	Control Arm			2134	2134			Control Arm	3523 52
	Inner Diameter: 17 mm for OE No.: 3520 92, 3520 93			2120	2120			Inner Diameter: 17 mm for OE No.: 3520 92, 3520 93	
3523 50	Control Arm			2415	2415			Control Arm	3523 50

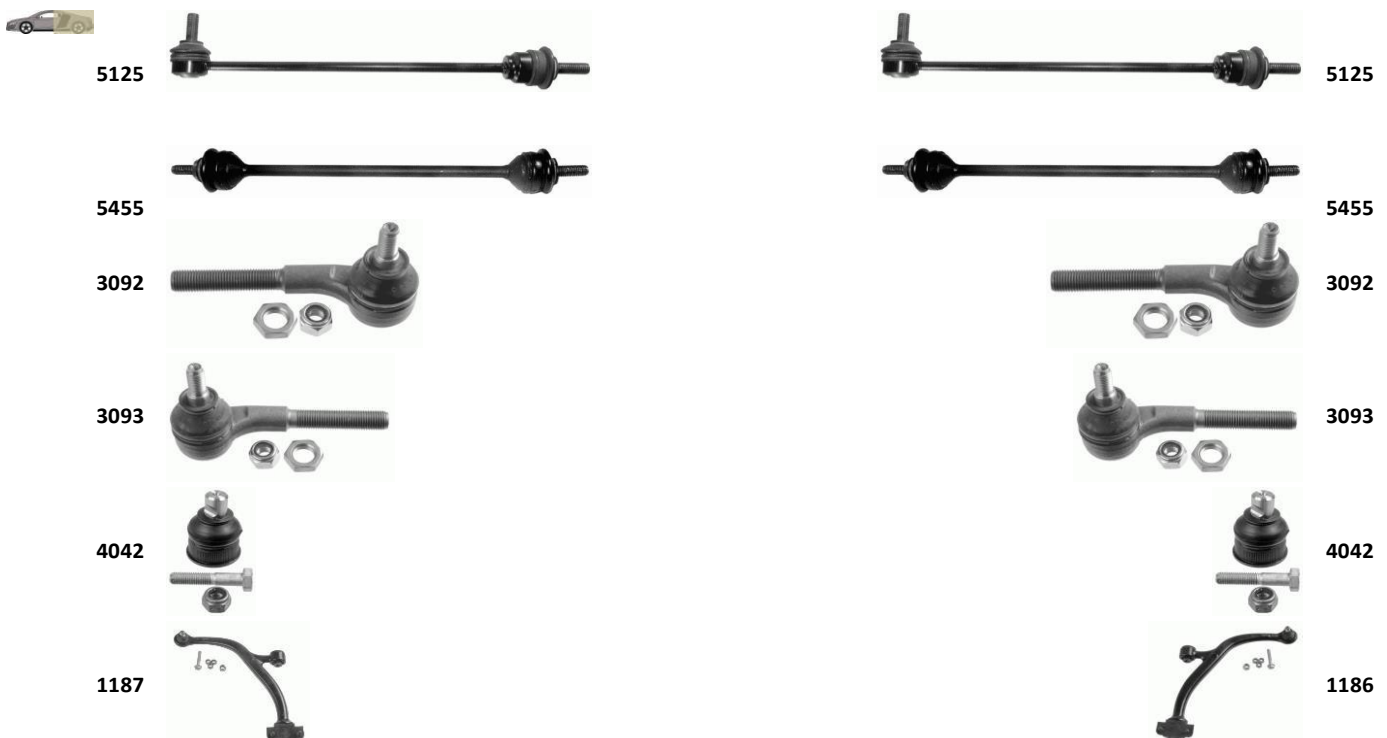

PEUGEOT



106 II (1)										-4,1996
OEM	Info	F / R	Type			Type	F / R	Info	OEM	
3817 47	with left-hand thread Thread Size: M14x1,5 without			6061	6061			with left-hand thread Thread Size: M14x1,5 without	3817 47	
5087 40	Suspension Rod			5125	5125			Suspension Rod	5087 40	
3817 14	with right-hand thread Thread Size: M14x1,5			3092	3092			with right-hand thread Thread Size: M14x1,5	3817 14	
3817 16	with right-hand thread Outer Thread: M14x1,5 mm			3093	3093			with right-hand thread Outer Thread: M14x1,5 mm	3817 16	
3640 36	with accessories			4042	4042			with accessories	3640 36	
3520 92	Control Arm Steel			1187	1186			Control Arm Steel	3520 93	
3520 78	Control Arm with rubber mounting with accessories Steel			1184	1185			Control Arm with rubber mounting with accessories Steel	3520 79	
3523 52	Control Arm Inner Diameter: 17 mm for OE No.: 3520 92, 3520 93			2134	2134			Control Arm Inner Diameter: 17 mm for OE No.: 3520 92, 3520 93	3523 52	
3523 50	Control Arm			2415	2415			Control Arm	3523 50	

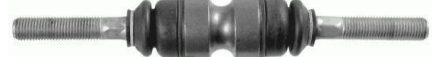

PEUGEOT

106 II (1)

-4,1996



1184



1185



2134



2134



2120



2120



2415



2415

107

-5,2015

OEM	Info	F / R	Type			Type	F / R	Info	OEM
5091 10	Suspension Rod Length: 92 mm Outer Thread: M8x1,25 mm with rubber mounting			5104	5104			Suspension Rod Length: 92 mm Outer Thread: M8x1,25 mm with rubber mounting	5091 10
3817 63	Inner Thread: M12x1,25 mm Outer Thread: M12x1,25 mm Length: 163 mm Cone Size: 15 mm			3099	3100			Inner Thread: M12x1,25 mm Outer Thread: M12x125 mm Length: 163 mm Cone Size: 15 mm	3817 64
3520 Q2				4229	4229				3520 Q2
3520 Q2	Control Arm			1194	1195			Control Arm	3521 L3
3520 Q2	for control arm			2124	2124			for control arm	3520 Q2
3520 Q2	for control arm			2125	2125			for control arm	3520 Q2



5104



5104



3099



3100



4229



4229



1194



1195





2124

2125



2124

2125

205				02.1983 - 07.1990					
OEM	Info	F / R	Type			Type	F / R	Info	OEM
3812 35				11137	11137				3812 35
3812 23				11138	11138				3812 23
5087 32	Suspension Rod with accessories			5123	5123			Suspension Rod with accessories	5087 32
3817 10	with accessories with right-hand thread Thread Size: M14x1,5			3510	3510			with accessories with right-hand thread Thread Size: M14x1,5	3817 10
3520 48	Control Arm with rubber mounting with accessories Steel			1196	1197			Control Arm with rubber mounting with accessories Steel	3521 31
3523 20	Mounting Type: Rubber-metal Bearing Width: 34,0 mm Outer Diameter: 28,0 mm Inner Diameter: 10,0 mm Control Arm			2126	2126			Mounting Type: Rubber-metal Bearing Width: 34,0 mm Outer Diameter: 28,0 mm Inner Diameter: 10,0 mm Control Arm	3523 20
3523 31	Mounting Type: Rubber-metal Bearing Width: 34,0 mm Outer Diameter: 28,0 mm Inner Diameter: 10,0mm			2308	2308			Mounting Type: Rubber-metal Bearing Width: 34,0 mm Outer Diameter: 28,0 mm Inner Diameter: 10,0mm	3523 31



11137

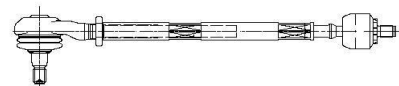

11137



11138



11138



5123



5123



3510



3510



1196



1197



2126



2126



2308



2308

PEUGEOT

205 II								01.1987 - 09.1998	
OEM	Info	F / R	Type			Type	F / R	Info	OEM
3812 35				11137	11137				3812 35
3812 23				11138	11138				3812 23
5087 32	Suspension Rod with accessories			5123	5123			Suspension Rod with accessories	5087 32
3817 10	with accessories with right-hand thread Thread Size: M14x1,5			3510	3510			with accessories with right-hand thread Thread Size: M14x1,5	3817 10
3520 48	Control Arm with rubber mounting with accessories Steel			1196	1197			Control Arm with rubber mounting with accessories Steel	3521 31
3523 20	Mounting Type:Rubber-metal Bearing Width: 34,0 mm Outer Diameter: 28,0 mm Inner Diameter: 10,0 mm Control Arm			2126	2126			Mounting Type:Rubber-metal Bearing Width: 34,0 mm Outer Diameter: 28,0 mm Inner Diameter: 10,0 mm Control Arm	3523 20
3523 31	Mounting Type:Rubber-metal Bearing Width: 34,0 mm Outer Diameter: 28,0 mm Inner Diameter: 10,0mm			2308	2308			Mounting Type:Rubber-metal Bearing Width: 34,0 mm Outer Diameter: 28,0 mm Inner Diameter: 10,0mm	3523 31



11137

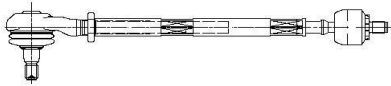

11137

11138



11138

5123



5123

3510



3510

1196



1197

2126



2126

2308



2308

PEUGEOT

206								-8,1998	
OEM	Info	F / R	Type			Type	F / R	Info	OEM
3812 C5				6354	6354				3812 C5
5087 45	Suspension Rod Steel with accessories			5105	5105			Suspension Rod Steel with accessories	5087 45
3817 14	with right-hand thread Thread Size: M14x1,5			3092	3092			with right-hand thread Thread Size: M14x1,5	3817 14
3817 16	with right-hand thread Outer Thread: M14x1,5 mm			3093	3093			with right-hand thread Outer Thread: M14x1,5 mm	3817 16
3520 G8	Control Arm with rubber mounting with accessories Steel			1456	1457			Control Arm with rubber mounting with accessories Steel	3521 C8
3520 P2	Control Arm			1454	1455			Control Arm	3521 K2
3523 77	Mounting Type:Rubber-metal Bearing for control arm			2122	2122			Mounting Type:Rubber-metal Bearing for control arm	3523 77
3523 76	Mounting Type:Rubber-metal Bearing for control arm			2309	2309			Mounting Type:Rubber-metal Bearing for control arm	3523 76
3523 80	Mounting Type:Rubber-metal Bearing for control arm			2310	2310			Mounting Type:Rubber-metal Bearing for control arm	3523 80



PEUGEOT

206 CC

-9,2

2310



2310



206 CC										-9,2
OEM	Info	F / R	Type			Type	F / R	Info	OEM	
3812 C5				6354	6354				3812 C5	
5087 45	Suspension Rod Steel with accessories			5105	5105			Suspension Rod Steel with accessories	5087 45	
3817 14	with right-hand thread Thread Size: M14x1,5			3092	3092			with right-hand thread Thread Size: M14x1,5	3817 14	
3817 16	with right-hand thread Outer Thread: M14x1,5 mm			3093	3093			with right-hand thread Outer Thread: M14x1,5 mm	3817 16	
3520 P2	Control Arm			1454	1455			Control Arm	3521 K2	
3523 76	Mounting Type: Rubber-metal Bearing for control arm			2309	2309			Mounting Type: Rubber-metal Bearing for control arm	3523 76	
3523 80	Mounting Type: Rubber-metal Bearing for control arm			2310	2310			Mounting Type: Rubber-metal Bearing for control arm	3523 80	



6354



6354



5105



5105



3092



3092



3093



3093



1454



1455



2309



2309



2310



2310



PEUGEOT

206+								-9,2015	
OEM	Info	F / R	Type			Type	F / R	Info	OEM
3812 C5				6354	6354				3812 C5
5087 45	Suspension Rod Steel with accessories			5105	5105			Suspension Rod Steel with accessories	5087 45
3817 14	with right-hand thread Thread Size: M14x1,5			3092	3092			with right-hand thread Thread Size: M14x1,5	3817 14
3817 16	with right-hand thread Outer Thread: M14x1,5 mm			3093	3093			with right-hand thread Outer Thread: M14x1,5 mm	3817 16
3520 G8	Control Arm with rubber mounting with accessories Steel			1456	1457			Control Arm with rubber mounting with accessories Steel	3521 C8
3523 77	Mounting Type: Rubber-metal Bearing for control arm			2122	2122			Mounting Type: Rubber-metal Bearing for control arm	3523 77
3523 76	Mounting Type: Rubber-metal Bearing for control arm			2309	2309			Mounting Type: Rubber-metal Bearing for control arm	3523 76



6354



6354



5105



5105



3092



3092



3093



3093



1456



1457



2122



2122



2309



2309



PEUGEOT

207								-7,2015	
OEM	Info	F / R	Type			Type	F / R	Info	OEM
3812 E8	Thread Measurement 1: M12x1,0 Thread Size 2: M16x1,5 Length: 195 mm			6045	6045			Thread Measurement 1: M12x1,0 Thread Size 2: M16x1,5 Length: 195 mm	3812 E8
5087 54	Suspension Rod Length: 330 mm Outer Thread: M10x1,5 mm			5106	5107			Suspension Rod Length: 330 mm Outer Thread: M10x1,5 mm	5087 55
3817 67	Length: 210 mm Cone Size: 14 mm Thread Size: M10x1,25 Inner Thread: M16x1,5 mm			3104	3105			Length: 210 mm Cone Size: 14 mm Thread Size: M10x1,25 Inner Thread: M16x1,5 mm	3817 68
3640 61				4049	4049				3640 61



207 CC								-7,2015	
OEM	Info	F / R	Type			Type	F / R	Info	OEM
3812 E8	Thread Measurement 1: M12x1,0 Thread Size 2: M16x1,5 Length: 195 mm			6045	6045			Thread Measurement 1: M12x1,0 Thread Size 2: M16x1,5 Length: 195 mm	3812 E8
5087 54	Suspension Rod Length: 330 mm Outer Thread: M10x1,5 mm			5106	5107			Suspension Rod Length: 330 mm Outer Thread: M10x1,5 mm	5087 55
3817 67	Length: 210 mm Cone Size: 14 mm Thread Size: M10x1,25 Inner Thread: M16x1,5 mm			3104	3105			Length: 210 mm Cone Size: 14 mm Thread Size: M10x1,25 Inner Thread: M16x1,5 mm	3817 68
3640 61				4049	4049				3640 61

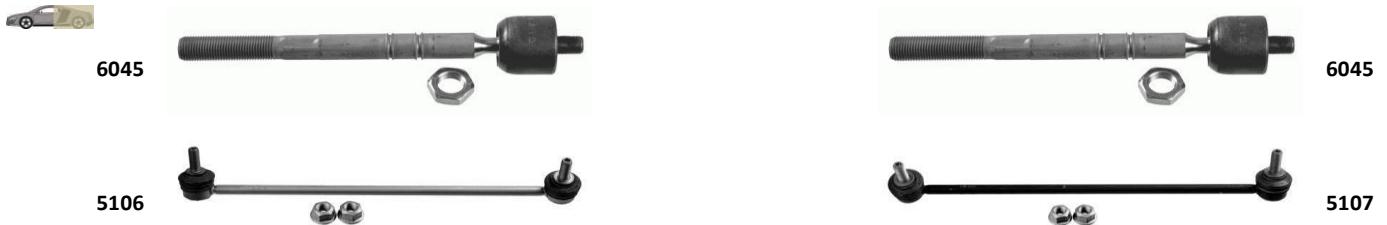

PEUGEOT

207 CC

-7,2015



208										-12,2015
OEM	Info	F / R	Type			Type	F / R	Info	OEM	
3812 E8	Thread Measurement 1: M12x1,0 Thread Size 2: M16x1,5 Length: 195 mm			6045	6045			Thread Measurement 1: M12x1,0 Thread Size 2: M16x1,5 Length: 195 mm	3812 E8	
3817 67	Length: 210 mm Cone Size: 14 mm Thread Size: M10x1,25 Inner Thread: M16x1,5 mm			3104	3105			Length: 210 mm Cone Size: 14 mm Thread Size: M10x1,25 Inner Thread: M16x1,5 mm	3817 68	



3008										-9,2015
OEM	Info	F / R	Type			Type	F / R	Info	OEM	
3812 F2	Thread Size: M14x1,5 Length: 257 mm			6046	6046			Thread Size: M14x1,5 Length: 257 mm	3812 F2	
5087 50	Suspension Rod Length: 335 mm Steel with accessories			5102	5102			Suspension Rod Length: 335 mm Steel with accessories	5087 50	
3817.76				3094	3509				3817.75	
3640 73	Outer Thread: M14x1,5 mm Cone Size: 17 mm			4232	4232			Outer Thread: M14x1,5 mm Cone Size: 17 mm	3640 73	
3520 V2	Cast Steel			1204	1205			Cast Steel	3521 R3	
3523 91	Mounting Type: Rubber-metal Bearing for control arm			2121	2121			Mounting Type: Rubber-metal Bearing for control arm	3523 91	
3523 77	Mounting Type: Rubber-metal Bearing for control arm			2122	2122			Mounting Type: Rubber-metal Bearing for control arm	3523 77	



PEUGEOT

3008 **-9,2015**



304				10.1969 - 10.1979					
OEM	Info	F / R	Type			Type	F / R	Info	OEM
3812 35				11137	11137				3812 35
3817 10	with accessories with right-hand thread Thread Size: M14x1,5			3510	3510			with accessories with right-hand thread Thread Size: M14x1,5	3817 10

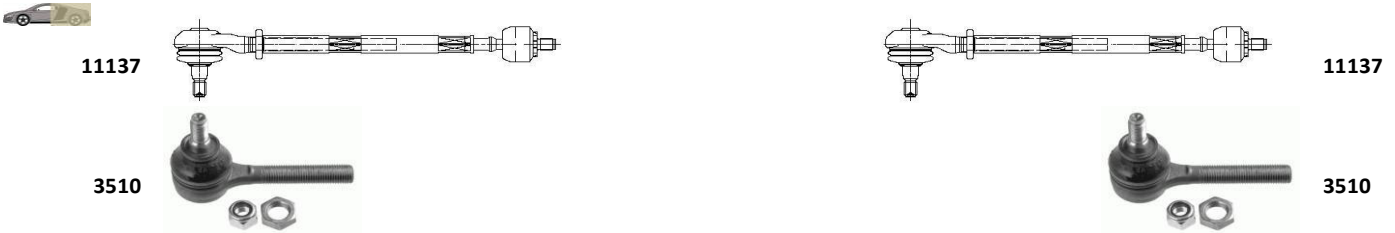

305				03.1970 - 04.1975					
OEM	Info	F / R	Type			Type	F / R	Info	OEM
3812 35				11137	11137				3812 35
3817 10	with accessories with right-hand thread Thread Size: M14x1,5			3510	3510			with accessories with right-hand thread Thread Size: M14x1,5	3817 10



PEUGEOT

305 I				08.1980 - 09.1982					
OEM	Info	F / R	Type			Type	F / R	Info	OEM
3812 35				11137	11137				3812 35
3817 10	with accessories with right-hand thread Thread Size: M14x1,5			3510	3510			with accessories with right-hand thread Thread Size: M14x1,5	3817 10



305 II				10.1982 - 07.1990					
OEM	Info	F / R	Type			Type	F / R	Info	OEM
	Thread Size: M14x1,5 with right-hand thread for OE No.: 3812.29/31			6062	6062			Thread Size: M14x1,5 with right-hand thread for OE No.: 3812.29/31	
3812 35				11137	11137				3812 35
3817 21	with right-hand thread Thread Size: M14x1,5			3388	3389			with right-hand thread Thread Size: M14x1,5	3817 22
3817 10	with accessories with right-hand thread Thread Size: M14x1,5			3510	3510			with accessories with right-hand thread Thread Size: M14x1,5	3817 10
3817 14	with right-hand thread Thread Size: M14x1,5			3092	3092			with right-hand thread Thread Size: M14x1,5	3817 14
3817 16	with right-hand thread Outer Thread: M14x1,5 mm			3093	3093			with right-hand thread Outer Thread: M14x1,5 mm	3817 16



PEUGEOT

306					04.1993 - 01.2015				
OEM	Info	F / R	Type			Type	F / R	Info	OEM
3812 92	Tube diameter at bellows seating 12,7 mm (TRW-steering)			6355	6355			Tube diameter at bellows seating 12,7 mm (TRW-steering)	3812 92
5087 39	Suspension Rod with accessories Steel			5103	5103			Suspension Rod with accessories Steel	5087 39
5087 38	Suspension Rod Plastic with accessories			5386	5386			Suspension Rod Plastic with accessories	5087 38
3817 10	with accessories with right-hand thread Thread Size: M14x1,5			3510	3510			with accessories with right-hand thread Thread Size: M14x1,5	3817 10
3640 30	with accessories			4174	4174			with accessories	3640 30
3640 31				4175	4175				3640 31
3640 48				4176	4176				3640 48
3640 49	with accessories			4177	4177			with accessories	3640 49
3520 H3	Control Arm Sheet Steel with rubber mounting, without ball joint			1594	1595			Control Arm Sheet Steel with rubber mounting, without ball joint	3521 E3



6355



6355



5103



5103



5386



5386



3510



3510



4174



4174



4175



4175



4176



4176



4177



4177

1594



1595



307										-8,2
OEM	Info	F / R	Type			Type	F / R	Info	OEM	
3812 E0	Thread Size: M14x1,5 Length: 306 mm Inner Thread: M14x1,5 mm			6047	6047			Thread Size: M14x1,5 Length: 306 mm Inner Thread: M14x1,5 mm	3812 E0	
3812 E5	Thread Measurement 1: M14x1,5 Thread Size 2: M14x1,5 Length: 324 mm			6048	6048			Thread Measurement 1: M14x1,5 Thread Size 2: M14x1,5 Length: 324 mm	3812 E5	
5087 50	Suspension Rod Length: 335 mm Steel with accessories			5102	5102			Suspension Rod Length: 335 mm Steel with accessories	5087 50	
3817 10	with accessories with right-hand thread Thread Size: M14x1,5			3510	3510			with accessories with right-hand thread Thread Size: M14x1,5	3817 10	
3817 14	with right-hand thread Thread Size: M14x1,5			3092	3092			with right-hand thread Thread Size: M14x1,5	3817 14	
3817 16	with right-hand thread Outer Thread: M14x1,5 mm			3093	3093			with right-hand thread Outer Thread: M14x1,5 mm	3817 16	
3640 53	with accessories			4043	4043			with accessories	3640 53	
3520 K8	Control Arm with rubber mounting Cast Steel			1188	1189			Control Arm with rubber mounting Cast Steel	3521 G8	
3523 91	Mounting Type: Rubber-metal Bearing for control arm			2121	2121			Mounting Type: Rubber-metal Bearing for control arm	3523 91	
3523 77	Mounting Type: Rubber-metal Bearing for control arm			2122	2122			Mounting Type: Rubber-metal Bearing for control arm	3523 77	



6047



6047



6048



6048



5102



5102



3510



3510



3092



3092



3093



3093



4043



4043



PEUGEOT

307

-8,2



1188



1189



2121



2121



2122



2122

307 CC								-3,2015	
OEM	Info	F / R	Type			Type	F / R	Info	OEM
3812 E0	Thread Size: M14x1,5 Length: 306 mm Inner Thread: M14x1,5 mm			6047	6047			Thread Size: M14x1,5 Length: 306 mm Inner Thread: M14x1,5 mm	3812 E0
3812 E5	Thread Measurement 1: M14x1,5 Thread Size 2: M14x1,5 Length: 324 mm			6048	6048			Thread Measurement 1: M14x1,5 Thread Size 2: M14x1,5 Length: 324 mm	3812 E5
5087 50	Suspension Rod Length: 335 mm Steel with accessories			5102	5102			Suspension Rod Length: 335 mm Steel with accessories	5087 50
3817 10	with accessories with right-hand thread Thread Size: M14x1,5			3510	3510			with accessories with right-hand thread Thread Size: M14x1,5	3817 10
3817 14	with right-hand thread Thread Size: M14x1,5			3092	3092			with right-hand thread Thread Size: M14x1,5	3817 14
3817 16	with right-hand thread Outer Thread: M14x1,5 mm			3093	3093			with right-hand thread Outer Thread: M14x1,5 mm	3817 16
3640 53	with accessories			4043	4043			with accessories	3640 53
3520 K8	Control Arm with rubber mounting Cast Steel			1188	1189			Control Arm with rubber mounting Cast Steel	3521 G8
3523 91	Mounting Type: Rubber-metal Bearing for control arm			2121	2121			Mounting Type: Rubber-metal Bearing for control arm	3523 91
3523 77	Mounting Type: Rubber-metal Bearing for control arm			2122	2122			Mounting Type: Rubber-metal Bearing for control arm	3523 77



6047



6047



6048



6048



5102



5102



3510



3510

PEUGEOT



3092



3092



3093



3093



4043



4043



1188



1189



2121



2121



2122



2122

308								-7,2015	
OEM	Info	F / R	Type			Type	F / R	Info	OEM
3812 F2	Thread Size: M14x1,5 Length: 257 mm			6046	6046			Thread Size: M14x1,5 Length: 257 mm	3812 F2
3812 F8				6056	6056				3812 F8
5087 50	Suspension Rod Length: 335 mm Steel with accessories			5102	5102			Suspension Rod Length: 335 mm Steel with accessories	5087 50
3817.76				3094	3509				3817.75
3640 73	Outer Thread: M14x1,5 mm Cone Size: 17 mm			4232	4232			Outer Thread: M14x1,5 mm Cone Size: 17 mm	3640 73
3520 V2	Cast Steel			1204	1205			Cast Steel	3521 R3
3523 91	Mounting Type: Rubber-metal Bearing for controlarm			2121	2121			Mounting Type: Rubber-metal Bearing for controlarm	3523 91
3523 77	Mounting Type: Rubber-metal Bearing for controlarm			2122	2122			Mounting Type: Rubber-metal Bearing for controlarm	3523 77



6046



6046



6056



6056



5102



5102

PEUGEOT



3094



3509



4232



4232



1204



1205



2121



2121



2122



2122

308 CC								-9,2015	
OEM	Info	F / R	Type			Type	F / R	Info	OEM
3812 F2	Thread Size: M14x1,5 Length: 257 mm			6046	6046			Thread Size: M14x1,5 Length: 257 mm	3812 F2
3812 F8				6056	6056				3812 F8
5087 50	Suspension Rod Length: 335 mm Steel with accessories			5102	5102			Suspension Rod Length: 335 mm Steel with accessories	5087 50
3817.76				3094	3509				3817.75
3640 73	Outer Thread: M14x1,5 mm Cone Size: 17 mm			4232	4232			Outer Thread: M14x1,5 mm Cone Size: 17 mm	3640 73
3520 V2	Cast Steel			1204	1205			Cast Steel	3521 R3
3523 91	Mounting Type: Rubber-metal Bearing for control arm			2121	2121			Mounting Type: Rubber-metal Bearing for control arm	3523 91
3523 77	Mounting Type: Rubber-metal Bearing for control arm			2122	2122			Mounting Type: Rubber-metal Bearing for control arm	3523 77



6046



6046



6056



6056



5102



5102





309 I				10.1985 - 12.1989					
OEM	Info	F / R	Type			Type	F / R	Info	OEM
3812 35				11137	11137				3812 35
5087 32	Suspension Rod with accessories			5123	5123			Suspension Rod with accessories	5087 32
3817 10	with accessories with right-hand thread Thread Size: M14x1,5			3510	3510			with accessories with right-hand thread Thread Size: M14x1,5	3817 10
3523 31	Mounting Type: Rubber-metal Bearing Width: 34,0 mm Outer Diameter: 28,0 mm Inner Diameter: 10,0 mm			2308	2308			Mounting Type: Rubber-metal Bearing Width: 34,0 mm Outer Diameter: 28,0 mm Inner Diameter: 10,0 mm	3523 31

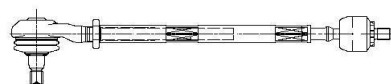

PEUGEOT

309 II								07.1989 - 12.1993	
OEM	Info	F / R	Type			Type	F / R	Info	OEM
3812 35				11137	11137				3812 35
5087 32	Suspension Rod with accessories			5123	5123			Suspension Rod with accessories	5087 32
3817 10	with accessories with right-hand thread Thread Size: M14x1,5			3510	3510			with accessories with right-hand thread Thread Size: M14x1,5	3817 10
3523 31	Mounting Type: Rubber-metal Bearing Width: 34,0 mm Outer Diameter: 28,0 mm Inner Diameter: 10,0 mm			2308	2308			Mounting Type: Rubber-metal Bearing Width: 34,0 mm Outer Diameter: 28,0 mm Inner Diameter: 10,0 mm	3523 31

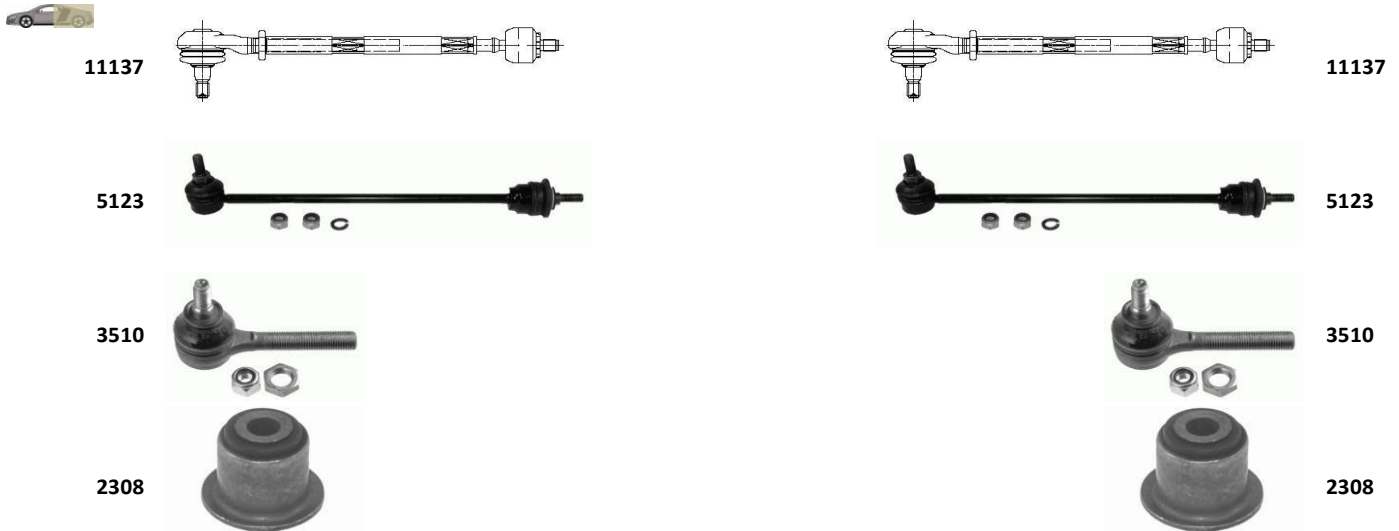

4007								-7,2015	
OEM	Info	F / R	Type			Type	F / R	Info	OEM
5087 58				5117	5117				5087 58
3817 74	Inner Thread: M14x1,5 mm Outer Thread: M12x1,25 mm Length: 76 mm			3116	3116			Inner Thread: M14x1,5 mm Outer Thread: M12x1,25 mm Length: 76 mm	3817 74
5178 48				5108	5109				5178 49

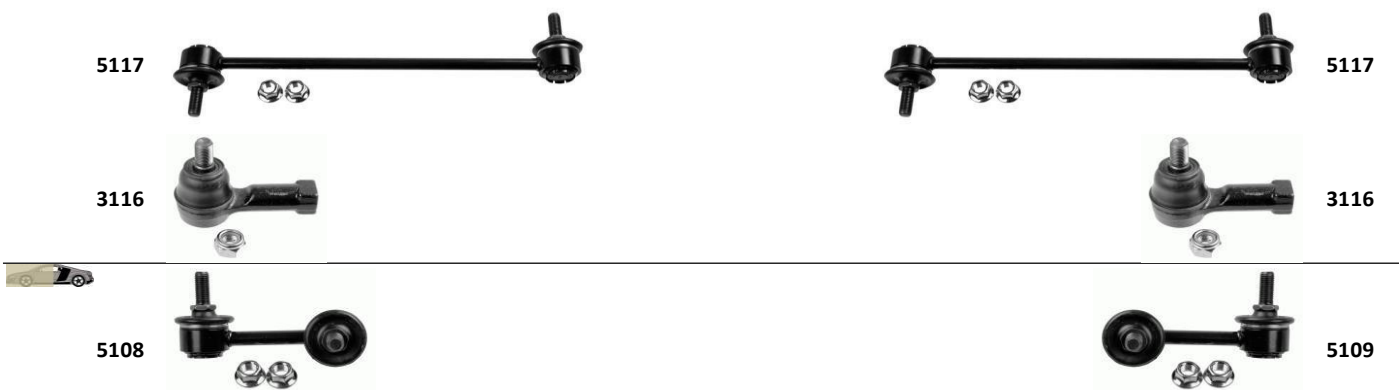

4008								-12,2015	
OEM	Info	F / R	Type			Type	F / R	Info	OEM
5178 48				5108	5109				5178 49



PEUGEOT

405 I						01.1987 - 12.1993			
OEM	Info	F / R	Type			Type	F / R	Info	OEM
3812 98	with right-hand thread Thread Size: M14x1,5			6215	6215			with right-hand thread Thread Size: M14x1,5	3812 98
5087 27	Length: 159 mm Suspension Rod			5387	5387			Length: 159 mm Suspension Rod	5087 27
3817 21	with right-hand thread Thread Size: M14x1,5			3388	3389			with right-hand thread Thread Size: M14x1,5	3817 22
3640 28	with accessories			4053	4053			with accessories	3640 28
3523 40				2311	2311				3523 40
3523 42				2312	2312				3523 42



6215



6215

5387



5387

3388



3389

4053



4053

2311



2311

2312



2312

405 II						08.1992 - 11.1999			
OEM	Info	F / R	Type			Type	F / R	Info	OEM
3812 98	with right-hand thread Thread Size: M14x1,5			6215	6215			with right-hand thread Thread Size: M14x1,5	3812 98
5087 27	Length: 159 mm Suspension Rod			5387	5387			Length: 159 mm Suspension Rod	5087 27
3817 21	with right-hand thread Thread Size: M14x1,5			3388	3389			with right-hand thread Thread Size: M14x1,5	3817 22
3640 28	with accessories			4053	4053			with accessories	3640 28
3523 40				2311	2311				3523 40
3523 42				2312	2312				3523 42



6215



6215

5387



5387

PEUGEOT

405 II

08.1992 - 11.1999



3388



3389



4053



4053



2311



2311



2312



2312

406				10.1995 - 04.2015					
OEM	Info	F / R	Type			Type	F / R	Info	OEM
3812 A9	Length: 296 mm			6063	6063			Length: 296 mm	3812 A9
5087 40	Suspension Rod			5125	5125			Suspension Rod	5087 40
5087 43	Suspension Rod with accessories			5110	5110			Suspension Rod with accessories	5087 43
3817 40	Suspended			3391	3390			Suspended	3817 39
3640 28	with accessories			4053	4053			with accessories	3640 28
3520 C0	Control Arm Steel			1460	1461			Control Arm Steel	3521 80
3523 60	Mounting Type: Rubber-metal Bearing for control arm			2315	2315			Mounting Type: Rubber-metal Bearing for control arm	3523 60
3523.61				2316	2316				3523.61
5178 38	Suspension Rod Plastic			5388	5388			Suspension Rod Plastic	5178 38
5131 80	Mounting Type: Rubber-metal Bearing			2313	2313			Mounting Type: Rubber-metal Bearing	5131 80
3640 35	Mounting Type: Rubber-metal Bearing L1/ L2: 52/24 mm Ø1/ Ø2: 45/37,5 mm Bore Ø: 14 mm			2314	2314			Mounting Type: Rubber-metal Bearing L1/ L2: 52/24 mm Ø1/ Ø2: 45/37,5 mm Bore Ø: 14 mm	3640 35



6063



6063



5125



5125

5110



5110



3391



3390



4053



4053



1460



1461



2315



2315



2316



2316



5388



5388



2313



2313



2314



2314



PEUGEOT

407							-4,2015			
OEM	Info	F / R	Type			Type	F / R	Info	OEM	
3812 E3				6053	6053				3812 E3	
3812 E3	Thread Size: M16x1,5			6052	6052			Thread Size: M16x1,5	3812 E3	
5087 52	Suspension Rod Length: 200 mm Thread Size: M16x1,5, M12x1,75			5111	5113			Suspension Rod Length: 200 mm Thread Size: M16x1,5, M12x1,75	5087 53	
5087 52				5112	5114				5087 53	
3817 58	Thread Size: M14x1,5, M10x1,25			3392	3393			Thread Size: M14x1,5, M10x1,25	3817 57	
3817 65	Thread Size: M12x1,5, M14x1,5 Length: 242 mm			3515	3516			Thread Size: M12x1,5, M14x1,5 Length: 242 mm	3817 66	
3640 57	Cone Size: 20,6 mm with fastening material			4054	4054			Cone Size: 20,6 mm with fastening material	3640 57	
3640 58				4055	4055				3640 58	
3520 N6	Control Arm			1452	1453			Control Arm	3521 J6	
3520 N7	Control Arm			1208	1209			Control Arm	3521 J7	
3523.AZ				2129	2129				3523.AZ	
3523 CA	for control arm			2130	2130			for control arm	3523 CA	
5178 46				5115	5115				5178 46	

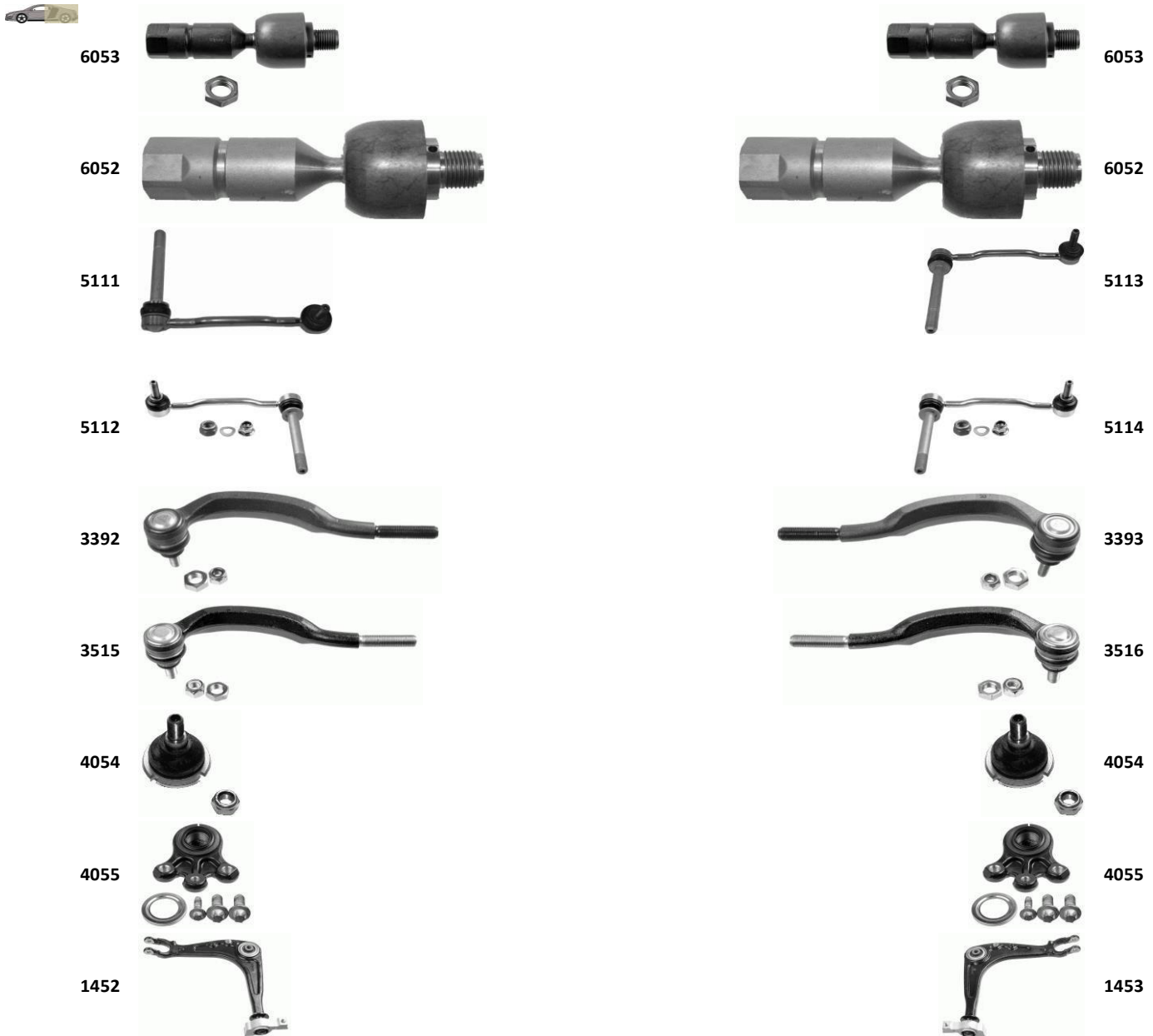

407

-4,2015

1208



1209



2129



2129



2130



2130



5115



5115



5008										-9,2015
OEM	Info	F / R	Type			Type	F / R	Info	OEM	
3812 F2	Thread Size: M14x1,5 Length: 257 mm			6046	6046			Thread Size: M14x1,5 Length: 257 mm	3812 F2	
5087 50	Suspension Rod Length: 335 mm Steel with accessories			5102	5102			Suspension Rod Length: 335 mm Steel with accessories	5087 50	
3817.76				3094	3509				3817.75	
3640 73	Outer Thread: M14x1,5 mm Cone Size: 17 mm			4232	4232			Outer Thread: M14x1,5 mm Cone Size: 17 mm	3640 73	
3520 V2	Cast Steel			1204	1205			Cast Steel	3521 R3	
3523 91	Mounting Type: Rubber-metal Bearing for control arm			2121	2121			Mounting Type: Rubber-metal Bearing for control arm	3523 91	
3523 77	Mounting Type: Rubber-metal Bearing for control arm			2122	2122			Mounting Type: Rubber-metal Bearing for control arm	3523 77	



6046



6046



5102



5102



3094



3509



PEUGEOT

5008

-9,2015



504				07.1968 - 07.1986					
OEM	Info	F / R	Type			Type	F / R	Info	OEM
3817 10	with accessories with right-hand thread Thread Size: M14x1,5			3510	3510			with accessories with right-hand thread Thread Size: M14x1,5	3817 10



3510



3510

505				05.1979 - 09.1995					
OEM	Info	F / R	Type			Type	F / R	Info	OEM
3817 10	with accessories with right-hand thread Thread Size: M14x1,5			3510	3510			with accessories with right-hand thread Thread Size: M14x1,5	3817 10



3510



3510

PEUGEOT

508								-10,2015	
OEM	Info	F / R	Type			Type	F / R	Info	OEM
	Thread Measurement 1: M16x1,5 Thread Size 2: M14x1,5 Length: 105 mm			6051	6051			Thread Measurement 1: M16x1,5 Thread Size 2: M14x1,5 Length: 105 mm	
3812 G3				6212	6212				3812 G3
5087 52	Suspension Rod Length: 200 mm Thread Size: M16x1,5, M12x1,75			5111	5113			Suspension Rod Length: 200 mm Thread Size: M16x1,5, M12x1,75	5087 53
5087 52				5112	5114				5087 53
	Inner Thread: M14x1,5 mm Thread Size: M12x1,50 Length: 210 mm			3513	3514			Inner Thread: M14x1,5 mm Thread Size: M12x1,5 Length: 210 mm	
3817 A1				3386	3387				3817 A2
3640 57	Cone Size: 20,6 mm with fastening material			4054	4054			Cone Size: 20,6 mm with fastening material	3640 57
3640 58				4055	4055				3640 58
3520 N6	Control Arm			1452	1453			Control Arm	3521 J6
3523.AZ				2129	2129				3523.AZ
3523 CA	for control arm			2130	2130			for control arm	3523 CA



6051



6051

6212



6212

5111



5113

5112



5114

3513



3514

3386



3387

PEUGEOT

508

-10,2015



604				08.1977 - 07.1987					
OEM	Info	F / R	Type			Type	F / R	Info	OEM
3817 10	with accessories with right-hand thread Thread Size: M14x1,5			3510	3510			with accessories with right-hand thread Thread Size: M14x1,5	3817 10



605				06.1989 - 09.1999					
OEM	Info	F / R	Type			Type	F / R	Info	OEM
3812 99	with accessories			6312	6312			with accessories	3812 99
3812 A6	Thread Size: M16x1,5 Diameter [mm]: 22			6216	6216			Thread Size: M16x1,5 Diameter [mm]: 22	3812 A6
5087 30	Suspension Rod			5126	5126			Suspension Rod	5087 30
3817 37	Outer Thread: M16x1,5 mm, M10x1,25 mm			3124	3125			Outer Thread: M16x1,5 mm, M10x1,25 mm	3817 38
3817 14	with right-hand thread Thread Size: M14x1,5			3092	3092			with right-hand thread Thread Size: M14x1,5	3817 14
3817 16	with right-hand thread Outer Thread: M14x1,5 mm			3093	3093			with right-hand thread Outer Thread: M14x1,5 mm	3817 16
3640 28	with accessories			4053	4053			with accessories	3640 28
3520 70	Control Arm Cast Steel			1462	1463			Control Arm Cast Steel	3520 71
3523.43	for control arm			2139	2139			for control arm	3523.43
5178 21	Suspension Rod			5389	5390			Suspension Rod	5178 22
3332 07				2317	2317				3332 07
5131 55				2318	2318				5131 55
5131 56	Mounting Type: Rubber-metal Bearing Control Arm			2319	2319			Mounting Type: Rubber-metal Bearing Control Arm	5131 56

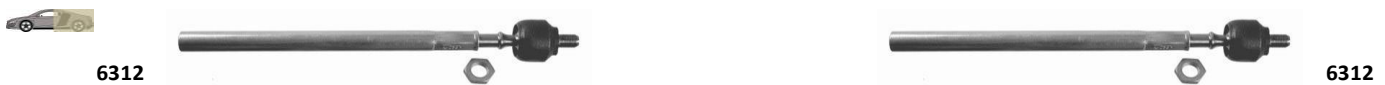

6216



6216

5126



5126

3124



3125

3092



3092

3093



3093

4053



4053

1462



1463

2139



2139



5389



5390

2317



2317

2318



2318

2319



2319

PEUGEOT

607								-1,2	
OEM	Info	F / R	Type			Type	F / R	Info	OEM
3812 C7	Length: 277 mm Thread Measurement 1: M16x1,5 Thread Size 2: M16x1,5			6217	6217			Length: 277 mm Thread Measurement 1: M16x1,5 Thread Size 2: M16x1,5	3812 C7
5087 43	Suspension Rod with accessories			5110	5110			Suspension Rod with accessories	5087 43
3817 37	Outer Thread: M16x1,5 mm, M10x1,25 mm			3124	3125			Outer Thread: M16x1,5 mm, M10x1,25 mm	3817 38
3640 28	with accessories			4053	4053			with accessories	3640 28
3520 70	Control Arm Cast Steel			1462	1463			Control Arm Cast Steel	3520 71
3523.43	for control arm			2139	2139			for control arm	3523.43
5178 21	Suspension Rod			5389	5390			Suspension Rod	5178 22



6217



6217

5110



5110

3124



3125

4053



4053

1462



1463

2139



2139



















5389



5390

PEUGEOT

806				06.1994 - 02.2015					
OEM	Info	F / R	Type			Type	F / R	Info	OEM
3812 A4	Length: 320 mm Outer Thread: M14x1,5 mm			6058	6058			Length: 320 mm Outer Thread: M14x1,5 mm	3812 A4
5087 35	Suspension Rod Thread Size: M12x1,25 Length: 122 mm Steel			5118	5118			Suspension Rod Thread Size: M12x1,25 Length: 122 mm Steel	5087 35
4059 09	with right-hand thread Inner Thread: M14x1,5 mm with accessories			3517	3517			with right-hand thread Inner Thread: M14x1,5 mm with accessories	4059 09
3520 94	Control Arm with ball joint, with rubber mounting, with fastening material Steel			1216	1217			Control Arm with ball joint, with rubber mounting, with fastening material Steel	3521 64



6058



6058



5118



5118



3517



3517



1216



1217



PEUGEOT

807							-2,2015			
OEM	Info	F / R	Type			Type	F / R	Info	OEM	
3812 E2	Length: 299 mm Thread Measurement 1: M14x1,5 Thread Size 2: M14x1,5			6054	6054			Length: 299 mm Thread Measurement 1: M14x1,5 Thread Size 2: M14x1,5	3812 E2	
3812 F0	Thread Measurement 1: M16x1,5 Thread Size 2: M14x1,5 Length: 282 mm			6055	6055			Thread Measurement 1: M16x1,5 Thread Size 2: M14x1,5 Length: 282 mm	3812 F0	
5087 51	Suspension Rod with accessories			5116	5116			Suspension Rod with accessories	5087 51	
4059 12	Length: 75 mm Cone Size: 15,45 mm Thread Measurement 1: M14x1,5 Thread Size 2: M10x1,25			3114	3114			Length: 75 mm Cone Size: 15,45 mm Thread Measurement 1: M14x1,5 Thread Size 2: M10x1,25	4059 12	
3817 73	Cone Size: 18 mm Thread Size: M14x1,5 Length: 80 mm			3115	3115			Cone Size: 18 mm Thread Size: M14x1,5 Length: 80 mm	3817 73	
3520 P6	Control Arm			1210	1211			Control Arm	3521 H1	
16 075 106 80	Control Arm Cast Steel Cone Size: 17 mm			1212	1213			Control Arm Cast Steel Cone Size: 17 mm	16 075 107 80	
3520 V8	Control Arm Cast Steel			1214	1215			Control Arm Cast Steel	3521 S0	



6054



6054



6055



6055



5116



5116



3114



3114



3115



3115



1210



1211





1212



1213

1214



1215

BIPPER										-8,2015
OEM	Info	F / R	Type			Type	F / R	Info	OEM	
5087 65	Suspension Rod Length: 290 mm Thread Size: M10x1,25			5122	5122			Suspension Rod Length: 290 mm Thread Size: M10x1,25	5087 65	
3817 86	Cone Size: 14 mm Thread Size: M10x1,25 Length: 112 mm			3122	3123			Cone Size: 14 mm Thread Size: M10x1,25 Length: 112 mm	3817 87	
3520 W3				4002	4002				3520 W3	
3520 W3	Control Arm Sheet Steel			1531	1532			Control Arm Sheet Steel	3521 S6	
3520 W3	Outer Diameter: 73,7 mm Inner Diameter: 12,4 mm Length: 66 mm			2000	2000			Outer Diameter: 73,7 mm Inner Diameter: 12,4 mm Length: 66 mm	3520 W3	
3520 W3	Outer Diameter: 42,3 mm Inner Diameter: 19 mm Length: 67,5 mm			2001	2001			Outer Diameter: 42,3 mm Inner Diameter: 19 mm Length: 67,5 mm	3520 W3	



5122



5122



3122



3123



4002



4002



1531



1532



2000



2000



2001



2001

PEUGEOT

BOXER								-6,2015	
OEM	Info	F / R	Type			Type	F / R	Info	OEM
16 077 445 80	Thread Measurement 1: M16x1,5 Thread Size 2: M16x1,5 Length: 239,5 mm			6059	6059			Thread Measurement 1: M16x1,5 Thread Size 2: M16x1,5 Length: 239,5 mm	16 077 445 80
3817 77	Suspended Inner Thread: M16x1,5 mm Outer Thread: M14x1,5 mm Length: 210 mm for left-/right-handtraffic			3518	3119			Suspended Inner Thread: M16x1,5 mm Outer Thread: M14x1,5 mm Length: 210 mm for left-/right-handtraffic	3817 70
3640 67				4056	4056				3640 67
3520 S0	Control Arm Cast Steel			1218	1219			Control Arm Cast Steel	3521 P1
3520 S1	Control Arm Cast Steel			1220	1221			Control Arm Cast Steel	3521 P2
5170 F5	Suspension Rod Length: 100 mm Pipe Ø: 8 mm Thread Size: M10x1,25			5119	5119			Suspension Rod Length: 100 mm Pipe Ø: 8 mm	5170 F5
3523 93				2131	2131				3523 93
3523 94				2132	2132				3523 94



PEUGEOT

BOXER (230L, 230P, ZCT)						03.1994 - 02.2015			
OEM	Info	F / R	Type			Type	F / R	Info	OEM
4006 24				6060	6060				4006 24
5087 37	Suspension Rod Thread Size: M12x1,25 Length: 134 mm Steel			5120	5120			Suspension Rod Thread Size: M12x1,25 Length: 134 mm Steel	5087 37
4018 A3	with right-handthread			3120	3120			with right-handthread	4018 A3
3640 32				4057	4057				3640 32
3640 33				4058	4058				3640 33
3640 55	with accessories			4059	4059			with accessories	3640 55
3640 54	with accessories			4060	4060			with accessories	3640 54
3520 95	Control Arm Cone Size: 20 mm			1222	1223			Control Arm Cone Size: 20 mm	3521 65
3520 96	Control Arm Cone Size: 24 mm			1224	1225			Control Arm Cone Size: 24 mm	3521 66
3523 93				2131	2131				3523 93
3523 94				2132	2132				3523 94

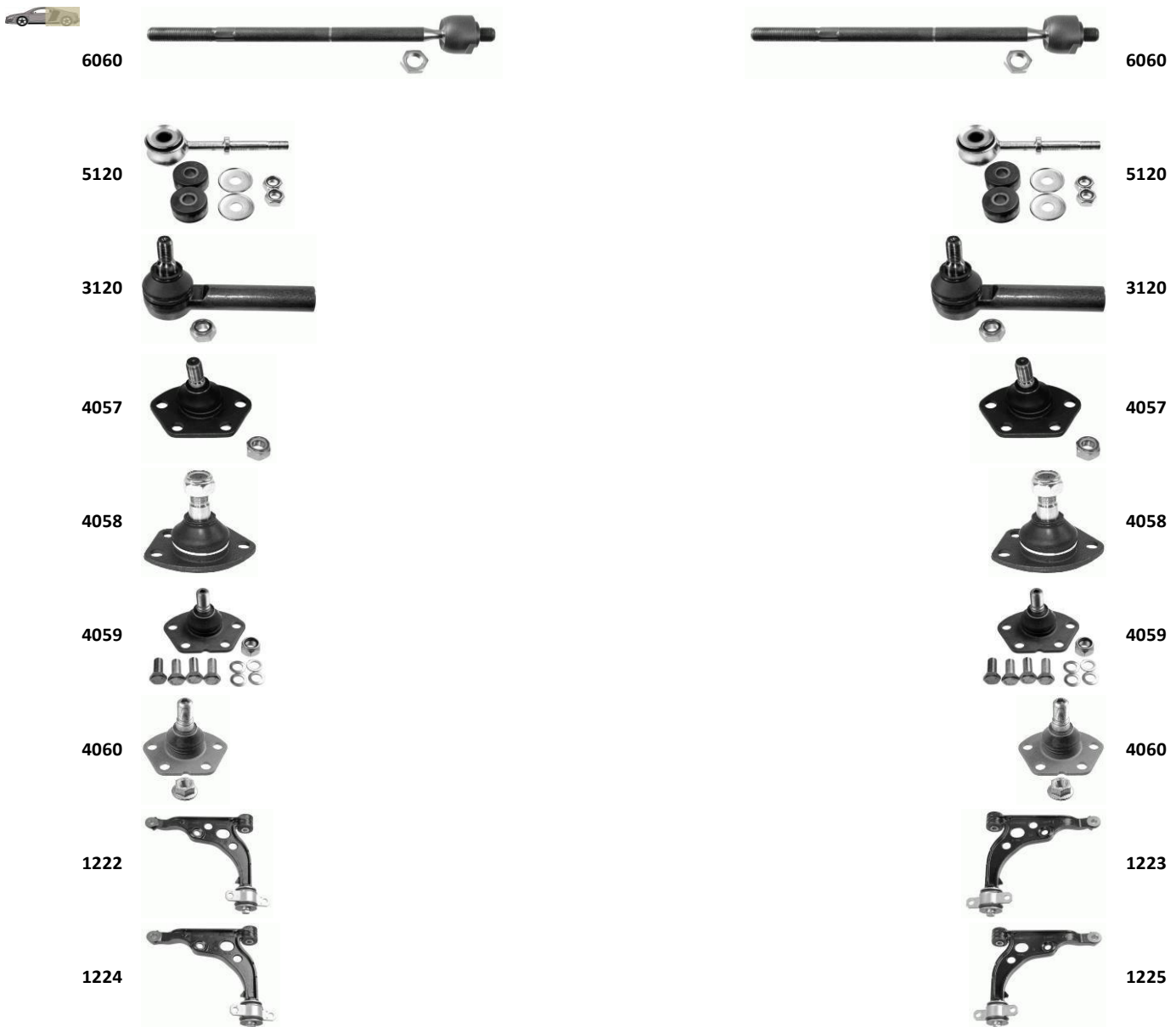

PEUGEOT

BOXER (230L, 230P, ZCT)

03.1994 - 02.2015



2131



2131



2132



2132



BOXER (244)

-1,2015

OEM	Info	F / R	Type			Type	F / R	Info	OEM
4006 24				6060	6060				4006 24
5087 37	Suspension Rod Thread Size: M12x1,25 Length: 134 mm Steel			5120	5120			Suspension Rod Thread Size: M12x1,25 Length: 134 mm Steel	5087 37
4018 A3	with right-handthread			3120	3120			with right-handthread	4018 A3
4018 E0	with accessories			3121	3121			with accessories	4018 E0
3640 55	with accessories			4059	4059			with accessories	3640 55
3640 54	with accessories			4060	4060			with accessories	3640 54
3520 95	Control Arm Cone Size: 20 mm			1222	1223			Control Arm Cone Size: 20 mm	3521 65
3520 96	Control Arm Cone Size: 24 mm			1224	1225			Control Arm Cone Size: 24 mm	3521 66
3523 93				2131	2131				3523 93
3523 94				2132	2132				3523 94
3523 AP				2133	2133				3523 AP



6060



6060



5120



5120



3120



3120



3121



3121



4059



4059



4060



4060



PEUGEOT

BOXER (244) -1,2015



EXPERT (222, 223, 224)								-12,1995	
OEM	Info	F / R	Type			Type	F / R	Info	OEM
3812 A4	Length: 320 mm Outer Thread: M14x1,5 mm			6058	6058			Length: 320 mm Outer Thread: M14x1,5 mm	3812 A4
5087 35	Suspension Rod Thread Size: M12x1,25 Length: 122 mm Steel			5118	5118			Suspension Rod Thread Size: M12x1,25 Length: 122 mm Steel	5087 35
4059 09	with right-hand thread Inner Thread: M14x1,5 mm with accessories			3517	3517			with right-hand thread Inner Thread: M14x1,5 mm with accessories	4059 09
4059 12	Length: 75 mm Cone Size: 15,45 mm Thread Measurement 1: M14x1,5 Thread Size 2: M10x1,25			3114	3114			Length: 75 mm Cone Size: 15,45 mm Thread Measurement 1: M14x1,5 Thread Size 2: M10x1,25	4059 12
3520 94	Control Arm with ball joint, with rubber mounting, with fastening material Steel			1216	1217			Control Arm with ball joint, with rubber mounting, with fastening material Steel	3521 64



6058

6058



5118



5118

PEUGEOT

EXPERT (222, 223, 224)

-12,1995



3517



3114



1217

EXPERT (VF3A_, VF3U_, VF3X_, VF3V_)

-7,2015

OEM	Info	F / R	Type			Type	F / R	Info	OEM
3812 F0	Thread Measurement 1: M16x1,5 Thread Size 2: M14x1,5 Length: 282 mm			6055	6055			Thread Measurement 1: M16x1,5 Thread Size 2: M14x1,5 Length: 282 mm	3812 F0
5087 56	Suspension Rod Thread Size: M12x1,75			5121	5121			Suspension Rod Thread Size: M12x1,75	5087 56
3817 73	Cone Size: 18 mm Thread Size: M14x1,5 Length: 80 mm			3115	3115			Cone Size: 18 mm Thread Size: M14x1,5 Length: 80 mm	3817 73
3520 R8	Control Arm Cast Steel Cone Size: 19 mm			1226	1227			Control Arm Cast Steel Cone Size: 19 mm	3521 N9



6055



6055

5121



5121

3115



3115

1226



1227

PEUGEOT

J5 (280L, 280P)						09.1981 - 09.1990				
OEM	Info	F / R	Type			Type	F / R	Info	OEM	
3817 11	Length: 80 mm Cone Size: 16 mm Inner Thread: M16x1,5 mm with right-hand thread Thread Size: M16x1,5			3103	3103			Length: 80 mm Cone Size: 16 mm Inner Thread: M16x1,5 mm with right-hand thread Thread Size: M16x1,5	3817 11	
3520 76	Control Arm without ball joint, with rubber mounting only with: 11591 Steel			1201	1200			Control Arm without ball joint, with rubber mounting only with: 11591 Steel	3521 52	



3103



3103



1201



1200



J5 (290L)						09.1990 - 02.1994				
OEM	Info	F / R	Type			Type	F / R	Info	OEM	
3817 11	Length: 80 mm Cone Size: 16 mm Inner Thread: M16x1,5 mm with right-hand thread Thread Size: M16x1,5			3103	3103			Length: 80 mm Cone Size: 16 mm Inner Thread: M16x1,5 mm with right-hand thread Thread Size: M16x1,5	3817 11	
3520 76	Control Arm without ball joint, with rubber mounting only with: 11591 Steel			1201	1200			Control Arm without ball joint, with rubber mounting only with: 11591 Steel	3521 52	



3103



3103



PARTNER

1201



1200



PEUGEOT

PARTNER								09.1990 - 02.1994	
OEM	Info	F / R	Type			Type	F / R	Info	OEM
3812 F4	Thread Size: M14x1,5 Length: 242 mm			6041	6041			Thread Size: M14x1,5 Length: 242 mm	3812 F4
3812 C0	with right-hand thread Thread Size: M14x1,5 with accessories			6042	6042			with right-hand thread Thread Size: M14x1,5 with accessories	3812 C0
5087 50	Suspension Rod Length: 335 mm Steel with accessories			5102	5102			Suspension Rod Length: 335 mm Steel with accessories	5087 50
5087 39	Suspension Rod with accessories Steel			5103	5103			Suspension Rod with accessories Steel	5087 39
3817.76				3094	3509				3817.75
3817 10	with accessories with right-hand thread Thread Size: M14x1,5			3510	3510			with accessories with right-hand thread Thread Size: M14x1,5	3817 10
3640 53	with accessories			4043	4043			with accessories	3640 53
3640 38	Cone Size: 16 mm with accessories			4044	4044			Cone Size: 16 mm with accessories	3640 38
3640 39	Cone Size: 16 mm with accessories			4045	4045			Cone Size: 16 mm with accessories	3640 39
3640 51	Cone Size: 18 mm			4046	4046			Cone Size: 18 mm	3640 51
3640 50	Cone Size: 18 mm			4228	4228			Cone Size: 18 mm	3640 50
3520 K8	Control Arm with rubber mounting Cast Steel			1188	1189			Control Arm with rubber mounting Cast Steel	3521 G8
3520 H5	Control Arm with rubber mounting, without ball joint Sheet Steel			1190	1191			Control Arm with rubber mounting, without ball joint Sheet Steel	3521 E5
3520 J3	Control Arm Steel			1192	1193			Control Arm Steel	3521 F3
3523 91	Mounting Type: Rubber-metal Bearing for control arm			2121	2121			Mounting Type: Rubber-metal Bearing for control arm	3523 91
3523 77	Mounting Type: Rubber-metal Bearing for control arm			2122	2122			Mounting Type: Rubber-metal Bearing for control arm	3523 77
3523.59				2418	2418				3523.59
96110483				2419	2419				96110483

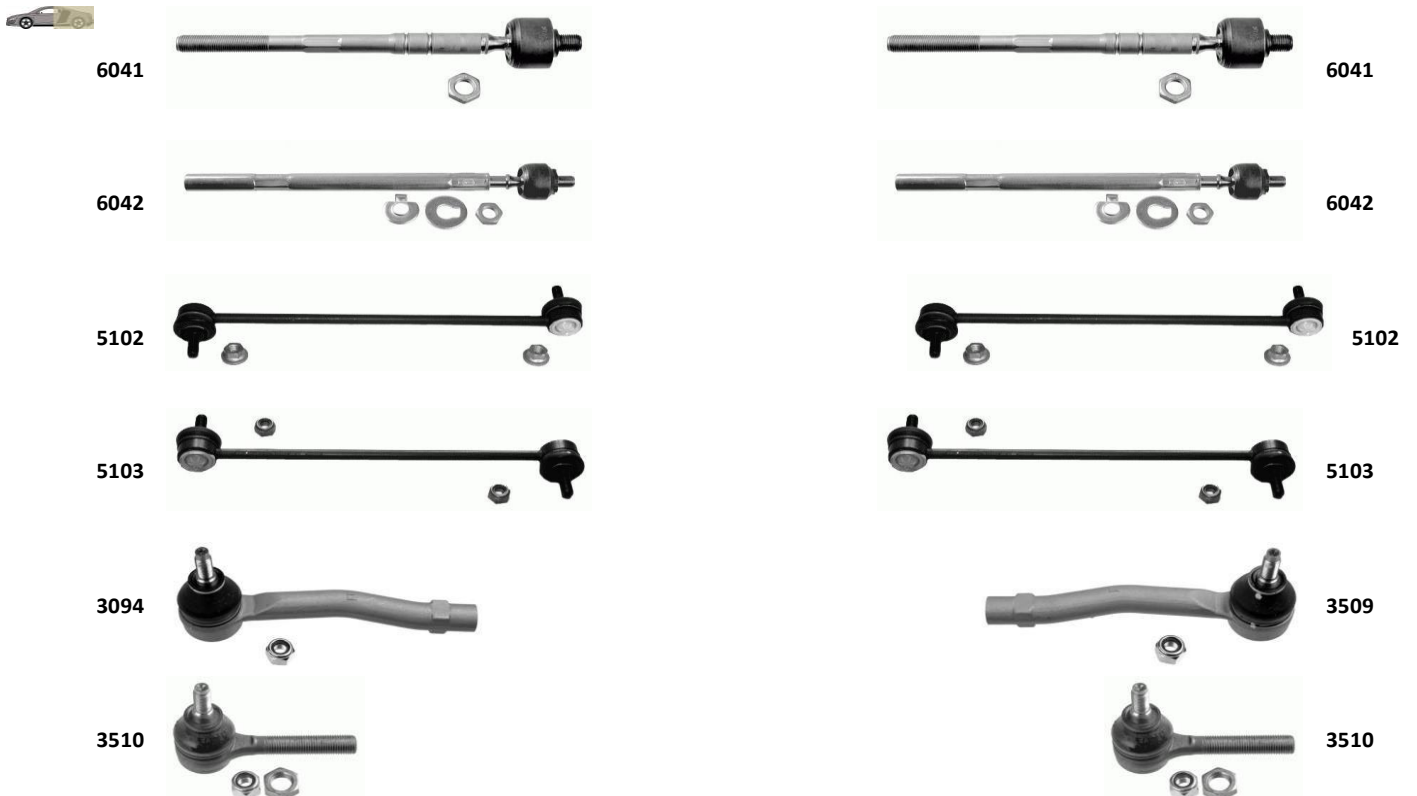

PEUGEOT

PARTNER

09.1990 - 02.1994



PEUGEOT

PARTNER Combispace (5F)								-5,1996	
OEM	Info	F / R	Type			Type	F / R	Info	OEM
3812 C0	with right-hand thread Thread Size: M14x1,5 with accessories			6042	6042			with right-hand thread Thread Size: M14x1,5 with accessories	3812 C0
5087 39	Suspension Rod with accessories Steel			5103	5103			Suspension Rod with accessories Steel	5087 39
3817 10	with accessories with right-hand thread Thread Size: M14x1,5			3510	3510			with accessories with right-hand thread Thread Size: M14x1,5	3817 10
3640 38	Cone Size: 16 mm with accessories			4044	4044			Cone Size: 16 mm with accessories	3640 38
3640 39	Cone Size: 16 mm with accessories			4045	4045			Cone Size: 16 mm with accessories	3640 39
3640 51	Cone Size: 18 mm			4046	4046			Cone Size: 18 mm	3640 51
3640 50	Cone Size: 18 mm			4228	4228			Cone Size: 18 mm	3640 50
3520 J3	Control Arm Steel			1192	1193			Control Arm Steel	3521 F3
3523.59				2418	2418				3523.59
96110483				2419	2419				96110483



6042



6042

5103



5103

3510



3510

4044



4044

4045



4045

4046



4046

4228



4228

1192



1193

PEUGEOT

PARTNER Tepee

-8,2015

PARTNER Combispac (5F)

-5,1996



PARTNER Tepee										-8,2015
OEM	Info	F / R	Type			Type	F / R	Info	OEM	
3812 F4	Thread Size: M14x1,5 Length: 242 mm			6041	6041			Thread Size: M14x1,5 Length: 242 mm	3812 F4	
5087 50	Suspension Rod Length: 335 mm Steel with accessories			5102	5102			Suspension Rod Length: 335 mm Steel with accessories	5087 50	
3817.76				3094	3509				3817.75	
3640 53	with accessories			4043	4043			with accessories	3640 53	
3520 K8	Control Arm with rubber mounting Cast Steel			1188	1189			Control Arm with rubber mounting Cast Steel	3521 G8	
3523 91	Mounting Type: Rubber-metal Bearing for control arm			2121	2121			Mounting Type: Rubber-metal Bearing for control arm	3523 91	
3523 77	Mounting Type: Rubber-metal Bearing for control arm			2122	2122			Mounting Type: Rubber-metal Bearing for control arm	3523 77	



PEUGEOT

RCZ

-10,2015

2122



2122



RCZ										-10,2015
OEM	Info	F / R	Type	6057	6057	Type	F / R	Info	OEM	
3812 F7									3812 F7	
5087 50	Suspension Rod Length: 335 mm Steel with accessories			5102	5102			Suspension Rod Length: 335 mm Steel with accessories	5087 50	
3640 73	Outer Thread: M14x1,5 mm Cone Size: 17 mm			4232	4232			Outer Thread: M14x1,5 mm Cone Size: 17 mm	3640 73	
3523 77	Mounting Type: Rubber-metal Bearing for control arm			2122	2122			Mounting Type: Rubber-metal Bearing for control arm	3523 77	



6057



6057



5102



5102



4232



4232



2122



2122

